

Alubin de México



Linea AW-90



www.alubin.com.mx

**PLANTA: CALLE 2 SUR No. 120, PARQUE INDUSTRIAL TOLUCA 2000. C.P. 50200
TOLUCA, EDO DE MÉXICO, MÉXICO. TEL.: (01 722) 2621500 FAX (01 722) 2621509**







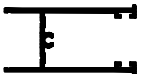

LINEA AW-90

CONTENIDO

	Pagina
Listado de Perfiles	1
Datos Técnicos	6
Listado de Herrajes y Viniles	21
Posibles Combinaciones	23
Graficas de Resistencia	35
Troquelados	40

LINEA AW-90

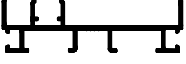
Listado de Perfiles

Clave Del Perfil	Descripcion del Perfil	Perfil	Peso (kg/m)	Perimetro Anodizable (mm)	Piezas Por Atado
8260 *	Zoclo Cabezal Duo-vent		0.881	387	4
8437 *	Intermedio de 42 mm. Duo-vent		0.564	254	6
8438 *	Jamba de 3 vias con Terminación		1.191	576	2
8439 *	Cabezal de 3 vias		2.088	864	2
8512 *	Encuentro Central		0.284	148	12
8513	Agregado Para 6 mm.		0.220	150	12
8514 *	Terminacion de jamba		0.228	117	12
8515 *	Jamba de 2 vias con Terminación		0.872	449	2
8516 *	Cabezal de 2 vias		1.492	624	2

* Clave Stock.

Sin marca Pedido Minimo de 250 Kg.

Alubin de México











PLANTA: CALLE 2 SUR No. 120, PARQUE INDUSTRIAL TOLUCA 2000. C.P. 50200 TOLUCA, EDO DE MÉXICO, MÉXICO. TEL.: (01 722) 2621500 FAX (01 722) 2621509

www.alubin.com.mx 2013

LINEA AW-90

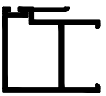
Listado de Perfiles

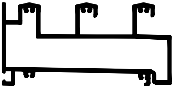
Clave Del Perfil	Descripcion del Perfil	Perfil	Peso (kg/m)	Perimetro Anodizable (mm)	Piezas Por Atado
8536 *	Jamba de 3 vias sin Terminación		1.024	481	2
8642 *	Agregado 14 mm. Duo-vent		0.196	133	12
8680 *	Riel de 2 Vias		0.931	388	2
8681 *	Riel de 3 Vias		1.360	565	2
9618 *	Cerco Duo-vent		0.986	310	2
9619 *	Cerco Reforzado Duo-vent		1.286	373	2
9631 *	Traslape Duo-vent		0.922	272	2
9632 *	Traslape Reforzado Duo-vent		1.427	347	2
9635	Riel de 3vias con fuente		2.770	706	1

* Clave Stock.

Sin marca Pedido Minimo de 250 Kg.



Alubin de México

2

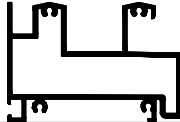
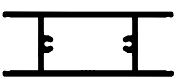
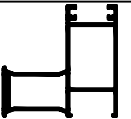
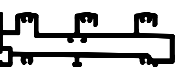

LINEA AW-90

Listado de Perfiles

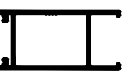
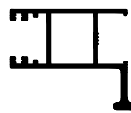
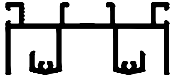
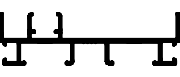





Clave Del Perfil	Descripcion del Perfil	Perfil	Peso (kg/m)	Perimetro Anodizable (mm)	Piezas Por Atado
9668	Riel de 2 vias con fuente		1.962	508	1
9734 *	Intermedio 85 mm. Duo-vent		1.132	305	2
9895 *	Cerco Reforzado Duo-vent		2.021	410	2
9897	Riel de 3 vias con fuente baja		2.657	914	1
10110 *	Traslape Duo-vent		1.160	301	2
10111 *	Cerco Duo-vent		1.206	336	2
10122 *	Cerco Reforzado Duo-vent		1.338	495	2
10242 *	Cabezal 2 Vias Ligero		1.279	471	2
10243 *	Jamba 2 Vias con Terminación Ligero		0.854	315	2

* Clave Stock.

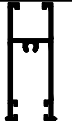
Sin marca Pedido Mínimo de 250 Kg.

LINEA AW-90

Listado de Perfiles

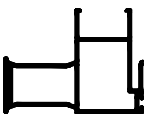
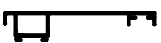
Clave Del Perfil	Descripcion del Perfil	Perfil	Peso (kg/m)	Perimetro Anodizable (mm)	Piezas Por Atado
10244 *	Traslape para vidrio 6 mm.		0.903	332	4
10245 *	Zoclo Cabezal para vidrio 6 mm.		0.881	326	4
10246 *	Cerco para vidrio 6 mm,		1.179	381	2
10247 *	Traslape para vidrio 6 mm.		1.122	506	2
137006	Marco Ciego		0.957	186	2
457003	Traslape de muro		0.476	238	8
478005 *	Riel adicional		0.505	211	6
521012 *	Traslape muy Reforzado Duo-vent		1.978	401	2
920007	Marco ciego serie AW 90X3		0.842	369	4

* Clave Stock.

Sin marca Pedido Minimo de 250 Kg.

LINEA AW-90

Listado de Perfiles

Clave Del Perfil	Descripcion del Perfil	Perfil	Peso (kg/m)	Perimetro Anodizable (mm)	Piezas Por Atado
920008	Marco ciego serie AW 90X2		0.731	310	4

* Clave Stock.

Sin marca Pedido Minimo de 250 Kg.

LINEA AW-90

Datos Técnicos

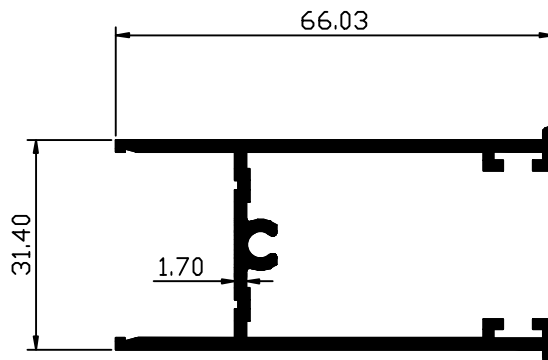

Clave: 8260
Zocio Cabezal Duo-vent
Peso: 0.881 Kg/m
Perimetro Anodizable: 38.7 cm

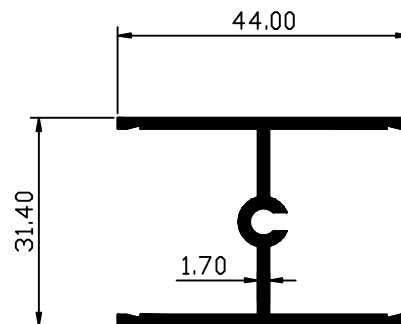

Clave: 8437
Intermedio de Cerco 42 Mm.
Duo-vent
Peso: 0.564 Kg/m
Perimetro Anodizable: 25.40 cm

LINEA AW-90

Datos Técnicos

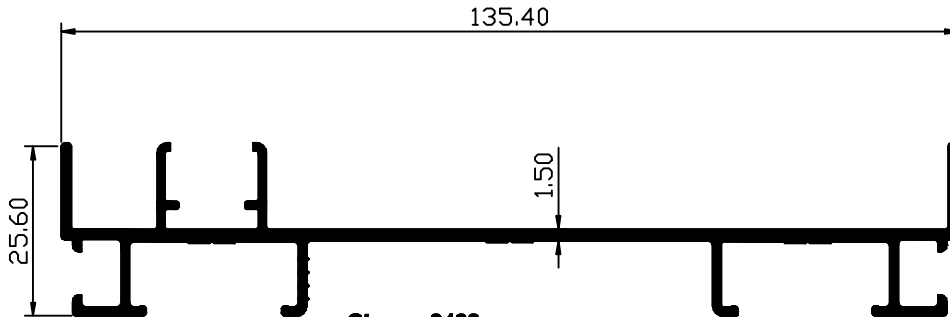

Clave: 8438
Jamba de 3 vías con Terminación
Peso: 1.191 Kg/m
Perímetro Anodizable: 57.6 cm

Clave: 8439
Cabezal de 3 vías
Peso: 2.088 Kg/m
Perímetro Anodizable: 86.40 cm

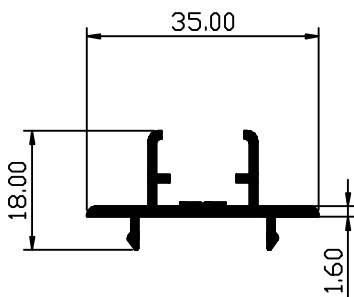
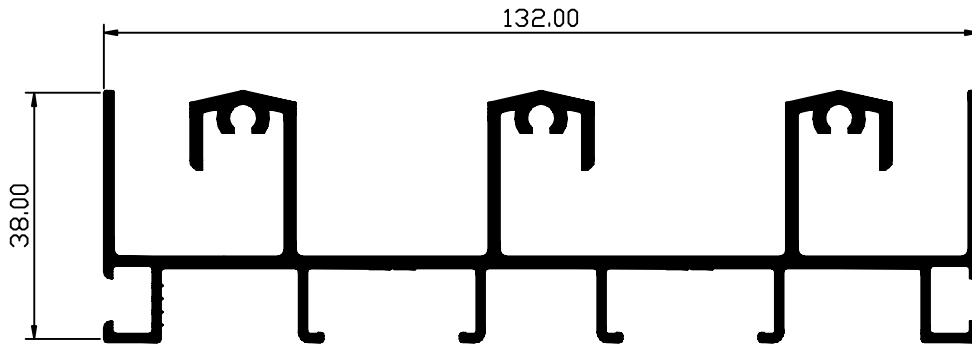

Clave: 8512
Encuentro Central
Peso: 0.284 Kg/m
Perímetro Anodizable: 14.80 cm

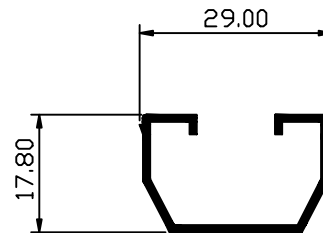

Clave: 8513
Agregado de 6 Mm.
Peso: 0.220 Kg/m
Perímetro Anodizable: 15.00 cm

LINEA AW-90

Datos Técnicos

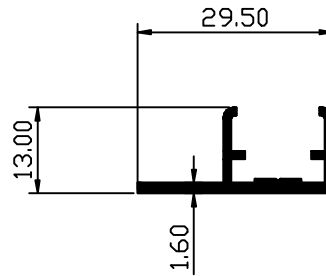

Clave: 8514
Terminación de Jamba
Peso: 0.228 Kg/m
Perimetro Anodizable: 11.70 cm

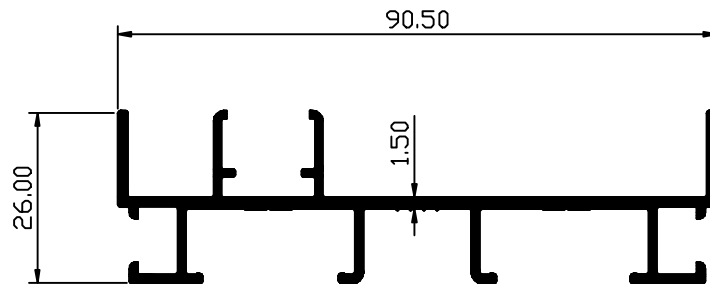

Clave: 8515
Jamba de 2 vias con Terminación
Peso: 0.872 Kg/m
Perimetro Anodizable: 44.90 cm

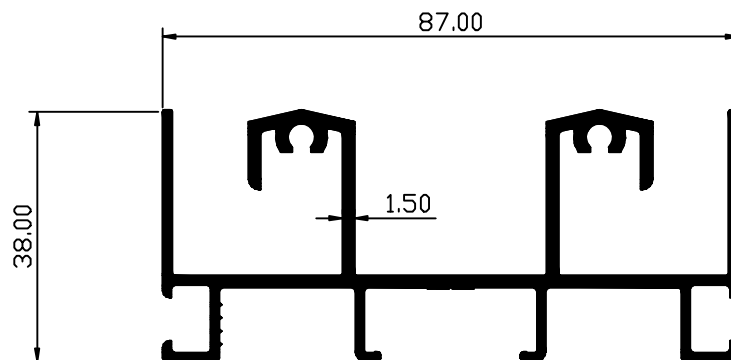

Clave: 8516
Cabezal de 2 vias
Peso: 1.492 Kg/m
Perimetro Anodizable: 62.40 cm

LINEA AW-90

Datos Técnicos

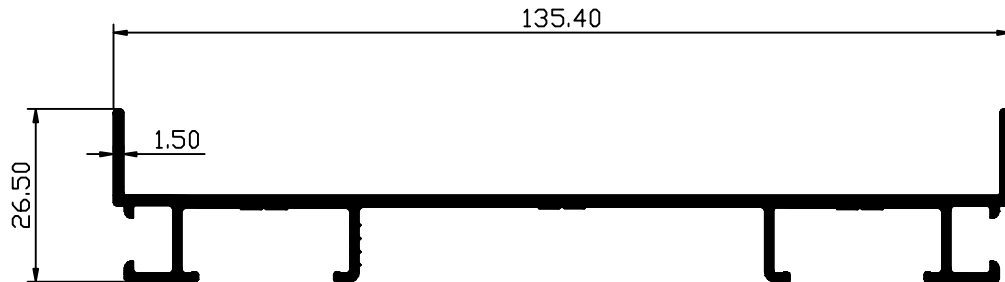

Clave: 8536
Jamba de 3 vías sin terminación
Peso: 1.024 Kg/m
Perímetro Anodizable: 48.10 cm

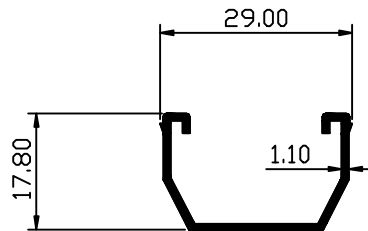

Clave: 8642
Agregado 14 Mm. Duo vent
Peso: 0.196 Kg/m
Perímetro Anodizable: 13.30 cm

Clave: 8680
Riel de 2 vías 19 Mm.
Peso: 0.931 Kg/m
Perímetro Anodizable: 38.80 cm

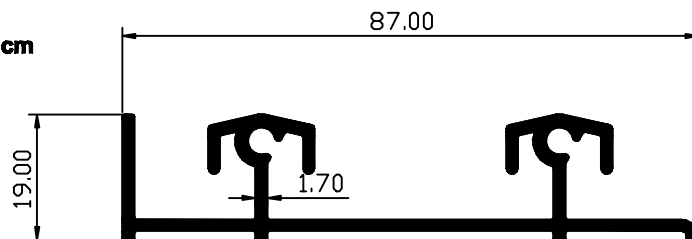

LINEA AW-90

Datos Técnicos

Clave: 8681
Riel de 3 vias 19 Mm.
Peso: 1.360 Kg/m
Perimetro Anodizable: 56.50 cm

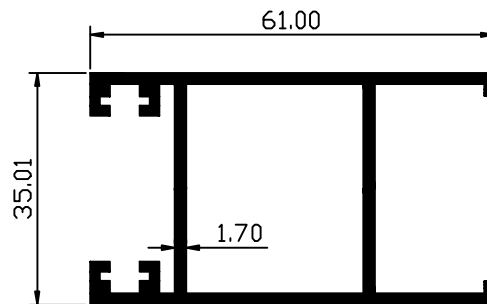
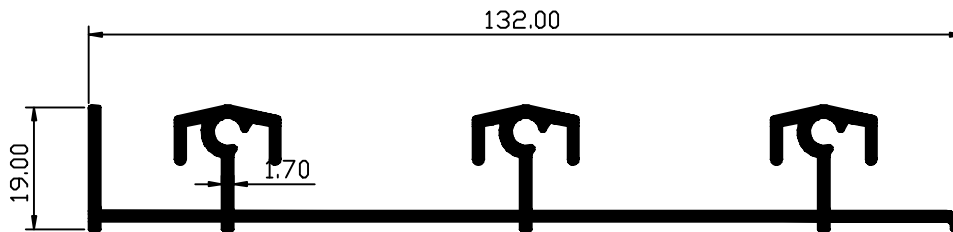

Clave: 9618
Cerco Duo vent
Peso: 0.986 Kg/m
Perimetro Anodizable: 31.0 cm

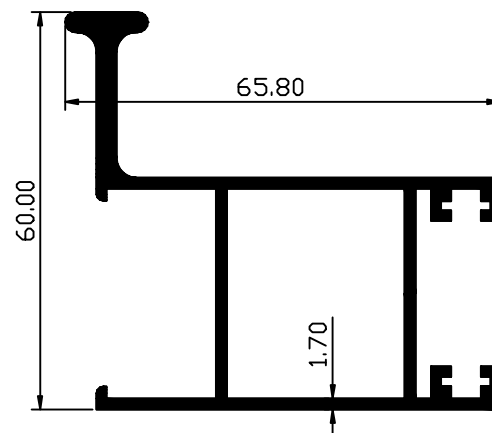

Clave: 9619
Cerco Reforzado Duo vent
Peso: 1.286 Kg/m
Perimetro Anodizable: 37.30 cm

LINEA AW-90

Datos Técnicos

Clave: 9631
Traslape Duo vent.
Peso: 0.922 Kg/m
Perimetro Anodizable: 27.20 cm

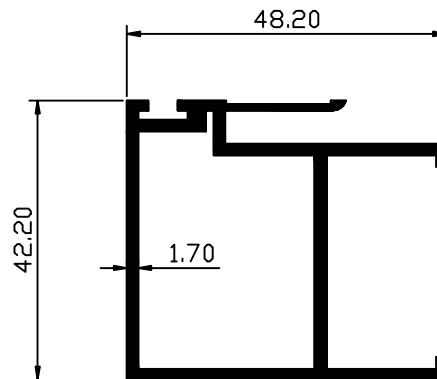

Clave: 9632
Traslape Reforzado Duo-vent
Peso: 1.427 Kg/m
Perimetro Anodizable: 34.70 cm

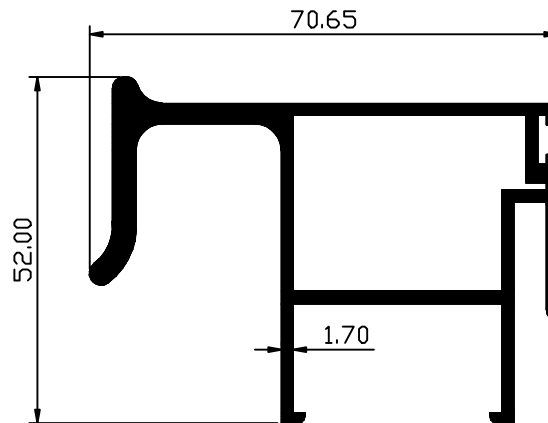

Clave: 9635
Riel de 3 vias con fuente.
Peso: 2.770 Kg/m
Perimetro Anodizable: 70.64 cm

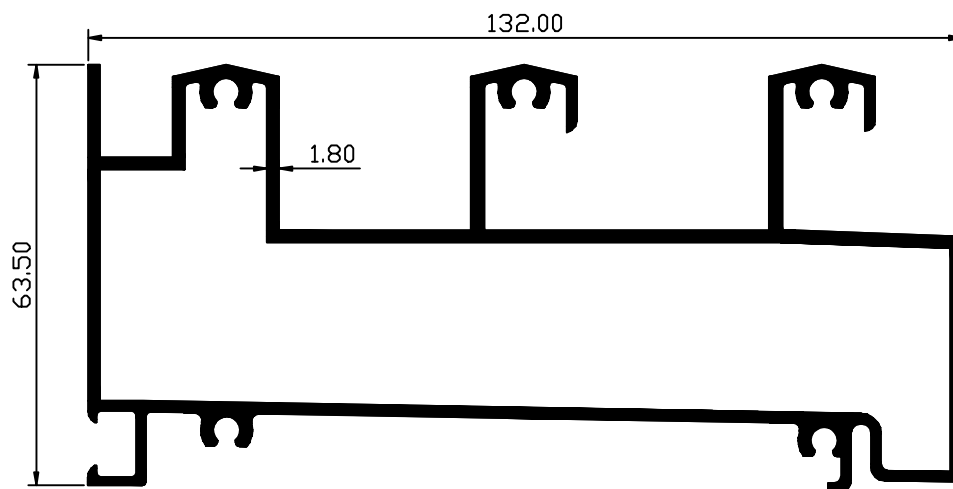

LINEA AW-90

Datos Técnicos

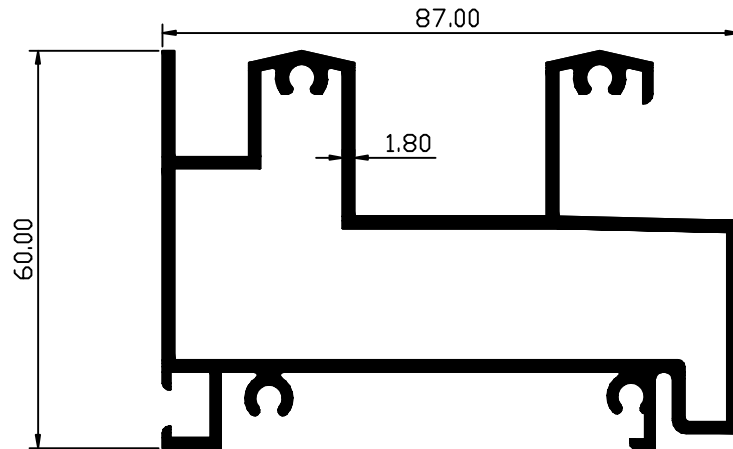

Clave: 9668
Riel de 2 Vías con Fuente
Peso: 1.962 Kg/m
Perímetro Anodizable: 50.8 cm

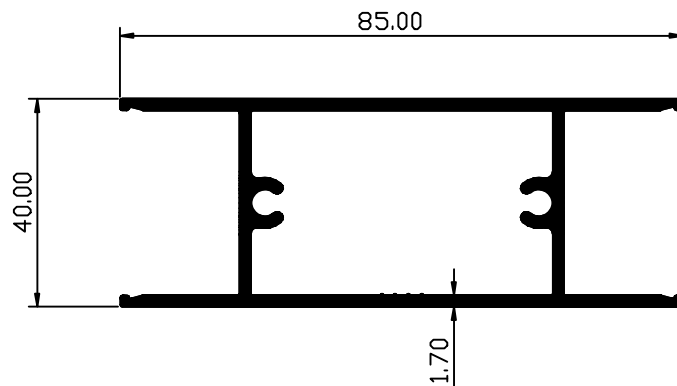

Clave: 9734
Intermedio 85 mm. Duo-Vent
Peso: 1.132 Kg/m
Perímetro Anodizable: 30.5 cm

LINEA AW-90

Datos Técnicos

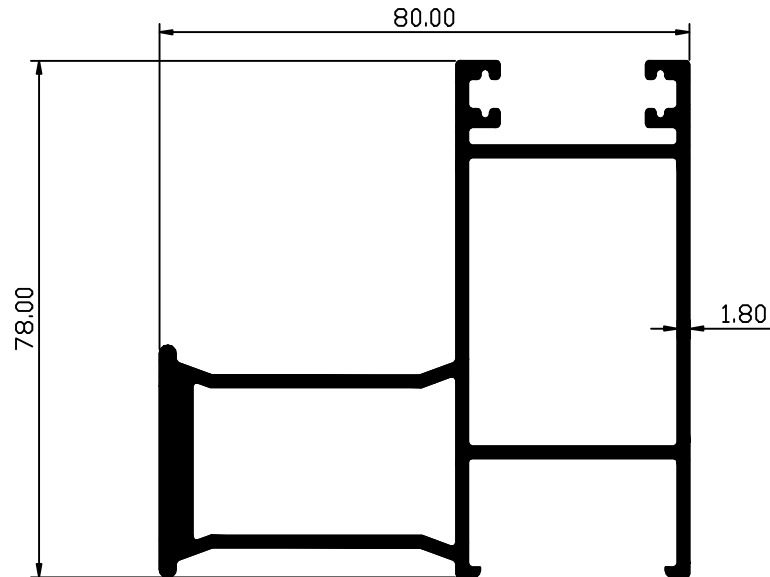

Clave: 9895
Cerco Reforzado Duo-Vent
Peso: 2.021 Kg/m
Perimetro Anodizable: 41 cm

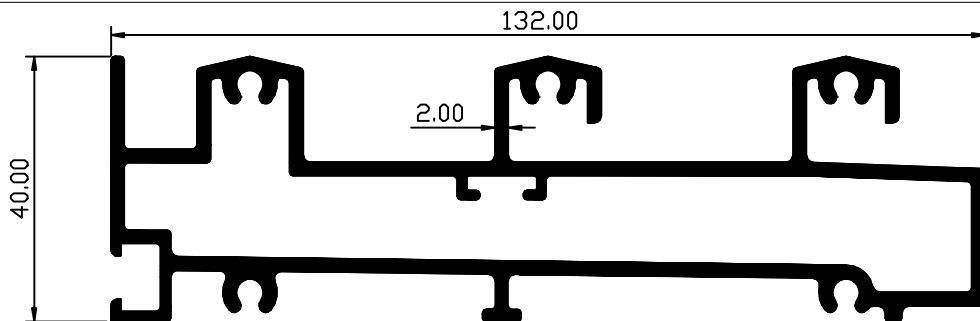

Clave: 9897
Riel de 3 Vías con Fuente Baja
Peso: 2.657 Kg/m
Perimetro Anodizable: 61.41 cm

LINEA AW-90

Datos Técnicos

Clave: 10110
Traslape Duo-Vent
Peso: 1.160 Kg/m
Perimetro Anodizable: 30.1 cm

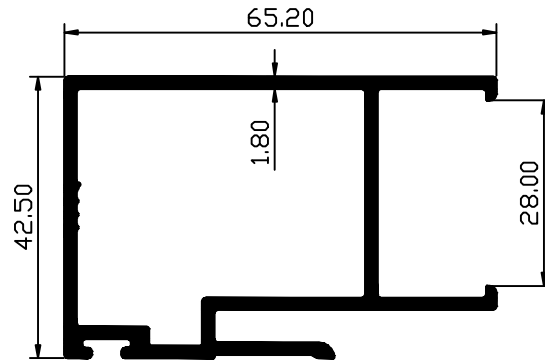

Clave: 10111
Cerco Duo-Vent
Peso: 1.206 Kg/m
Perimetro Anodizable: 33.61 cm

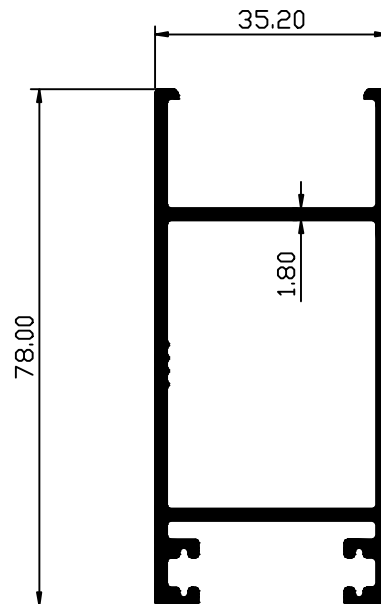

LINEA AW-90

Datos Técnicos

Clave: 10122
Cerco Reforzado Duo-Vent
Peso: 1.338 Kg/m
Perimetro Anodizable: 49.51 cm

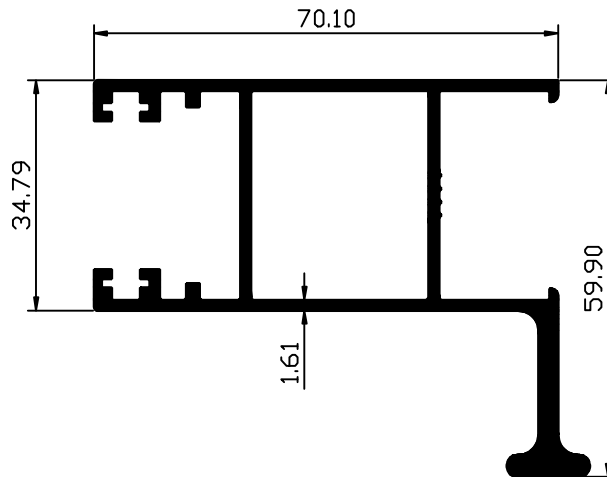

Clave: 10242
Cabezal 2 Vías Ligero
Peso: 1.279 Kg/m.
Perimetro Anodizable: 47.11 cm.

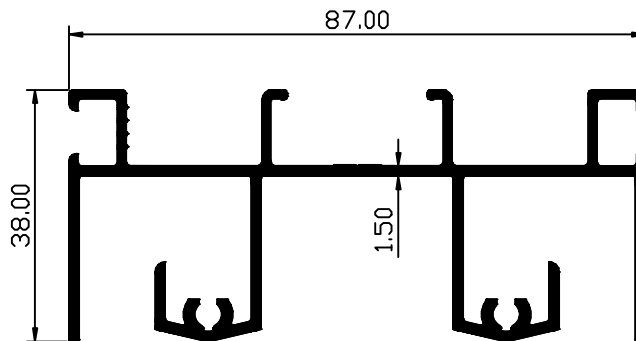

LINEA AW-90

Datos Técnicos

Clave: 10243
Jamba de 2 Vías con Terminación Liger
Peso: 0.854 Kg/m.
Perímetro Anodizable: 31.51 cm.

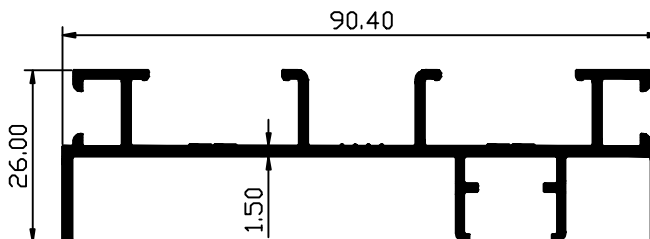

Clave: 10244
Traslape para Vidrio de 6 mm.
Peso: 0.903 Kg/m.
Perímetro Anodizable: 33.21 cm.

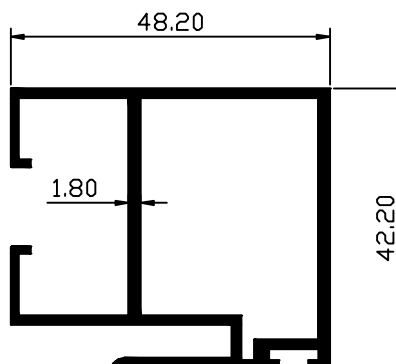

Clave: 10245
Zocio Cabezal para Vidrio 6 mm
Peso: 0.881 Kg/m.
Perímetro Anodizable: 32.61 cm.

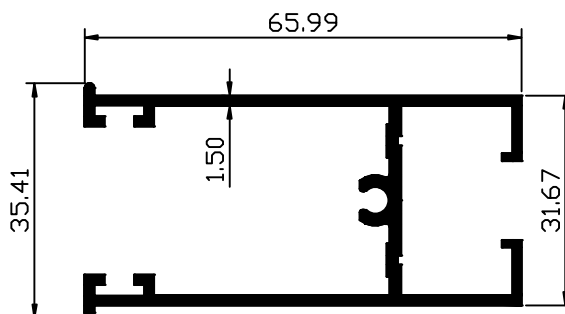

LINEA AW-90

Datos Técnicos

Clave: 10246
Cerco para Vidrio 6 mm
Peso: 1.179 Kg/m.
Perimetro Anodizable: 38.11 cm.

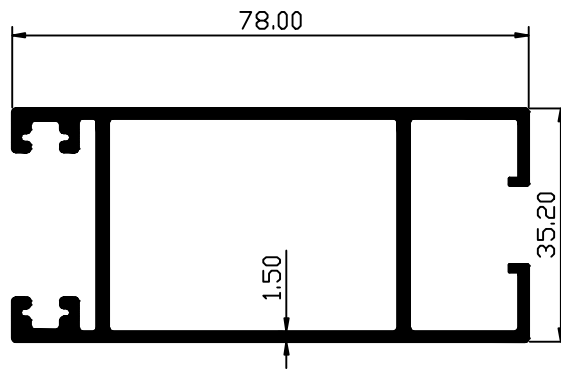

Clave: 10247
Traslape para vidrio 6mm
Peso: 1.122 Kg/m.
Perimetro Anodizable: 50.01 cm.

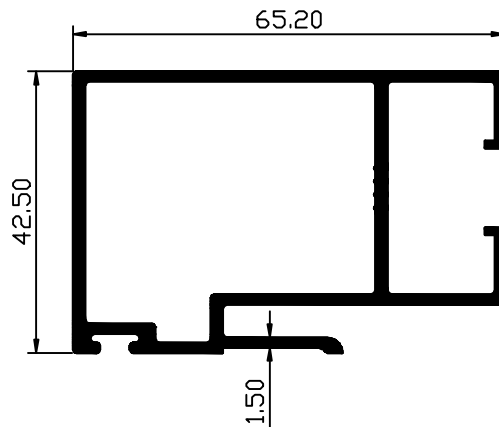

LINEA AW-90

Datos Técnicos

Clave: 137006
Marco ciego
Peso: 0.957 Kg/m.
Perímetro Anodizable: 18.61 cm.

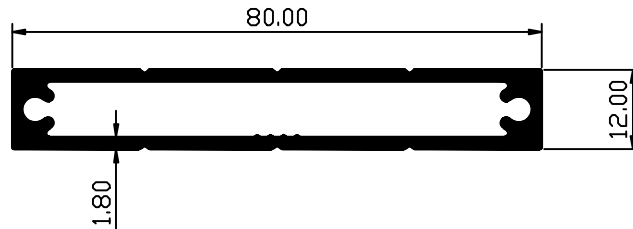

Clave: 457003
Traslape de muro
Peso: 0.476 Kg/m.
Perímetro Anodizable: 23.81 cm.

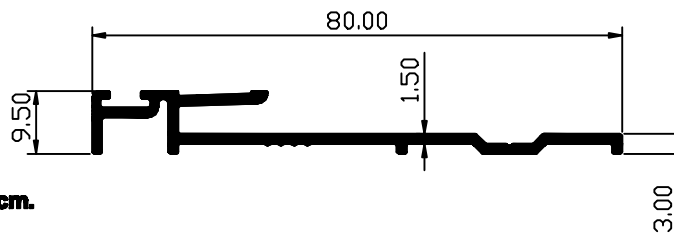

Clave: 478005
Riel adicional
Peso: 0.505 Kg/m.
Perímetro Anodizable: 21.11 cm.

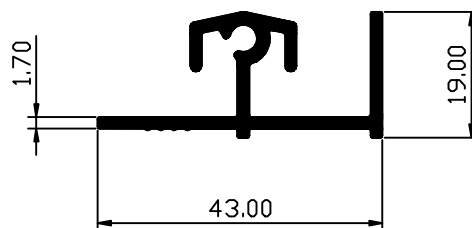

LINEA AW-90

Datos Técnicos

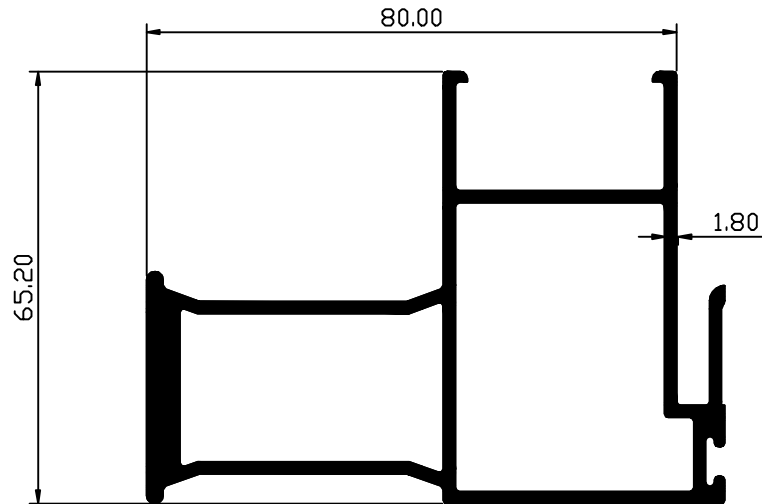

Clave: 521012
Traslape Muy Reforzado Duo-Vent
Peso: 1.978 Kg/m
Perimetro Anodizable: 40.1 cm

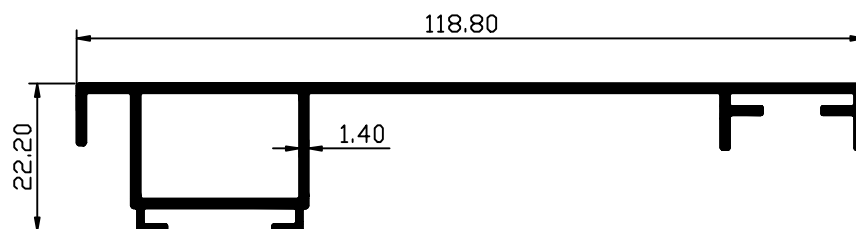

Clave: 920007
Marco Ciego Serie AW 90X3
Peso: 0.842Kg/m
Perimetro Anodizable: 36.87 cm

LINEA AW-90

Datos Técnicos

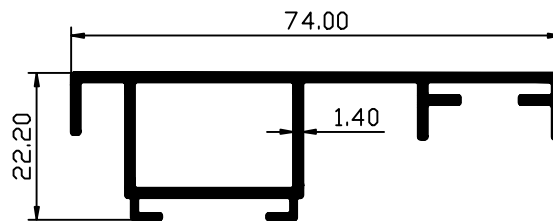

Clave: 920008
Marco Ciego Serie AW 90 X 2
Peso: 0.731 Kg/m
Perímetro Anodizable: 31.03 cm

Alubin de México





20



PLANTA: CALLE 2 SUR No. 120, PARQUE INDUSTRIAL TOLUCA 2000. C.P. 50200 TOLUCA, EDO DE MÉXICO, MÉXICO. TEL.: (01 722) 2621500 FAX (01 722) 2621509

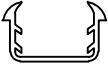

LINEA AW-90

Listado de herrajes y viniles

Dibujo	Descripción	Numero de Parte
	Goma de mosquitero	31297
	Vinil para 6mm	1823
	Vinil para 14mm (duo-vent)	1810
	Cepillo alto/cola	38114
	P.V.C de unión	27278
	Jaladera de Mosquitero	43461
	Sello de traslape con cepillo 9000	29072
	Ruedas regulables hasta 70Kg	PL-01115
	Ruedas regulables hasta 100Kg	PL-01122
	Ruedas regulables hasta 195Kg	PL-01120

LINEA AW-90

Listado de herrajes y viniles

Dibujo	Descripción	Numero de Parte
	Jaladera externa	012-1
	Cierre embutido con llave Master	012-3
	Cierre embutido con llave Cilindro	12258

LINEA AW-90

Ventana Corrediza de Doble Hoja

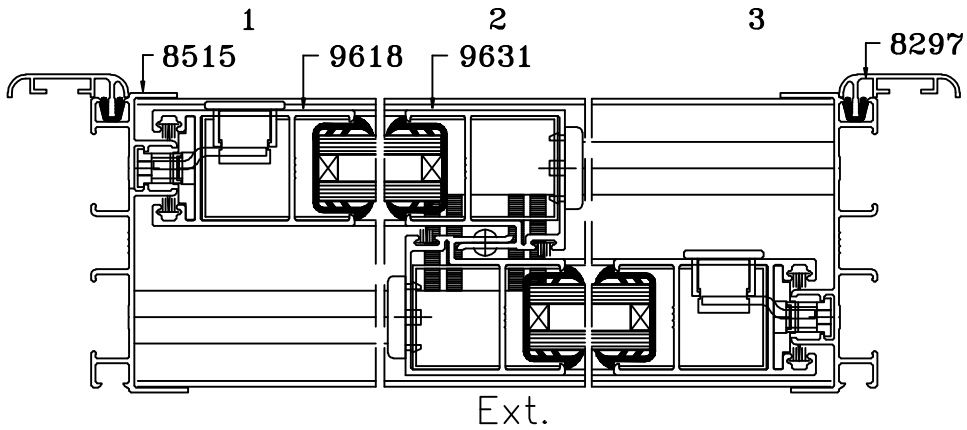
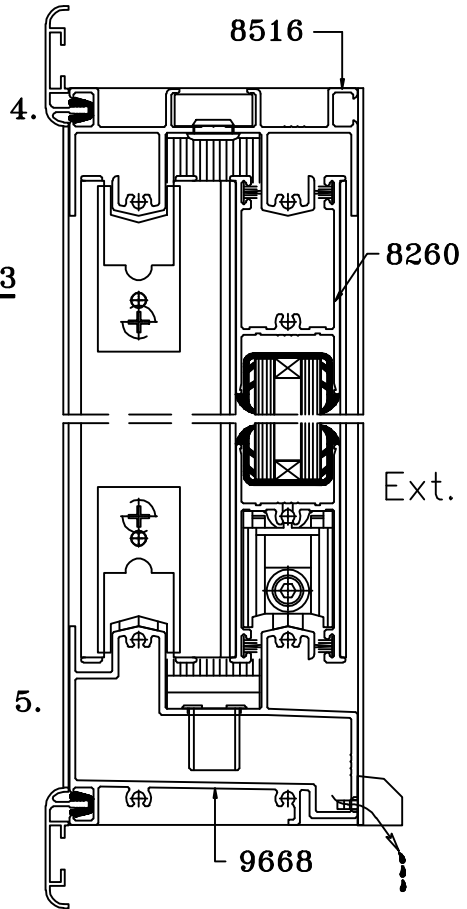
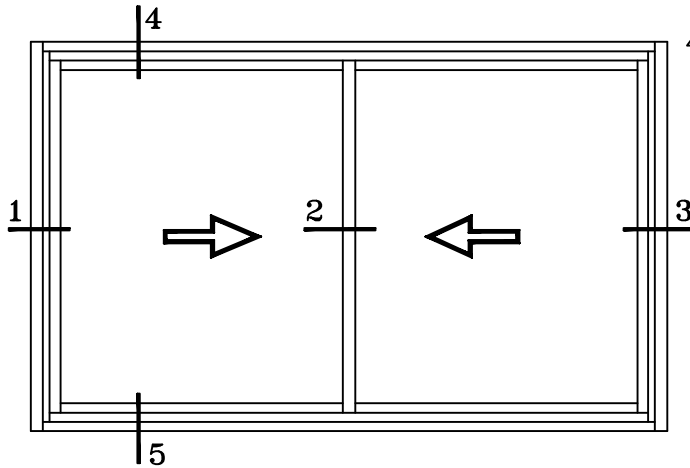

LINEA AW-90

Ventana Corrediza de Triple Hoja

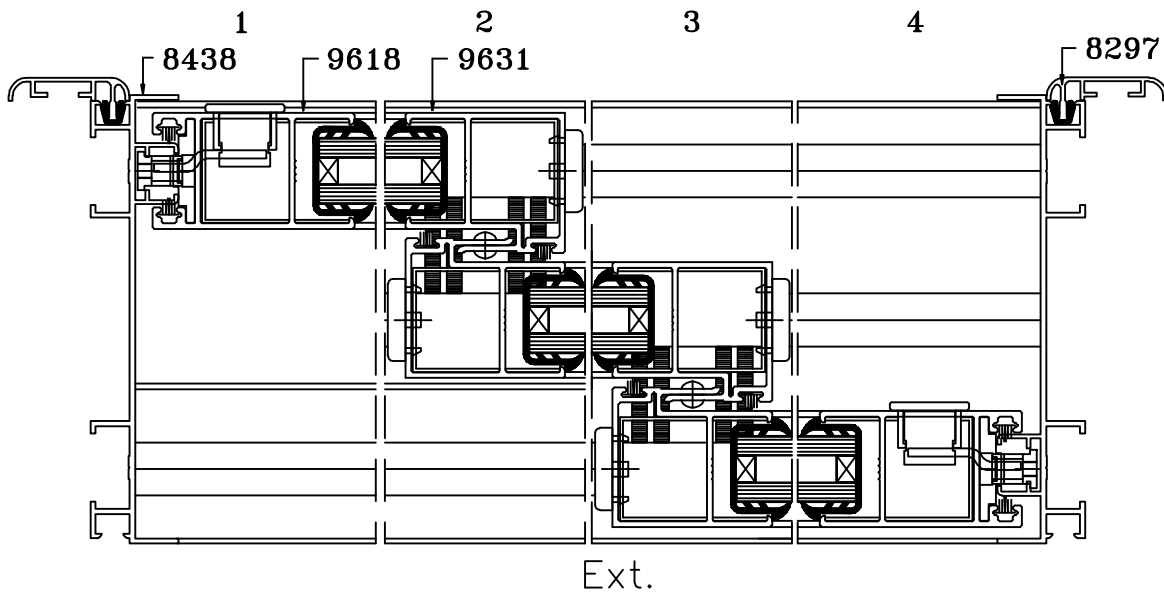
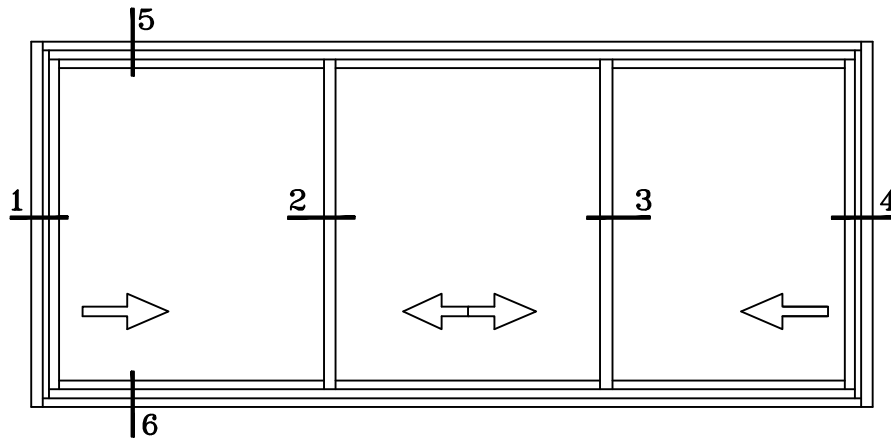

LINEA AW-90

Ventana Corrediza de Triple Hoja

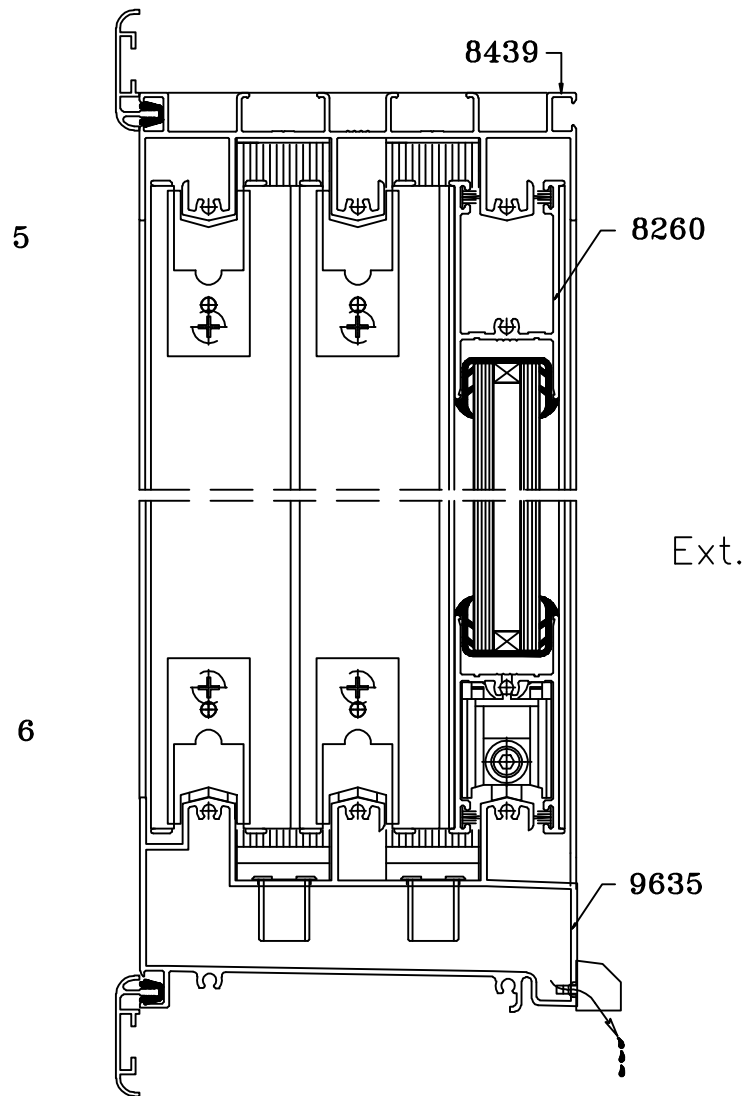

LINEA AW-90

Ventana Corrediza de Doble Hoja Con Fijo Interior

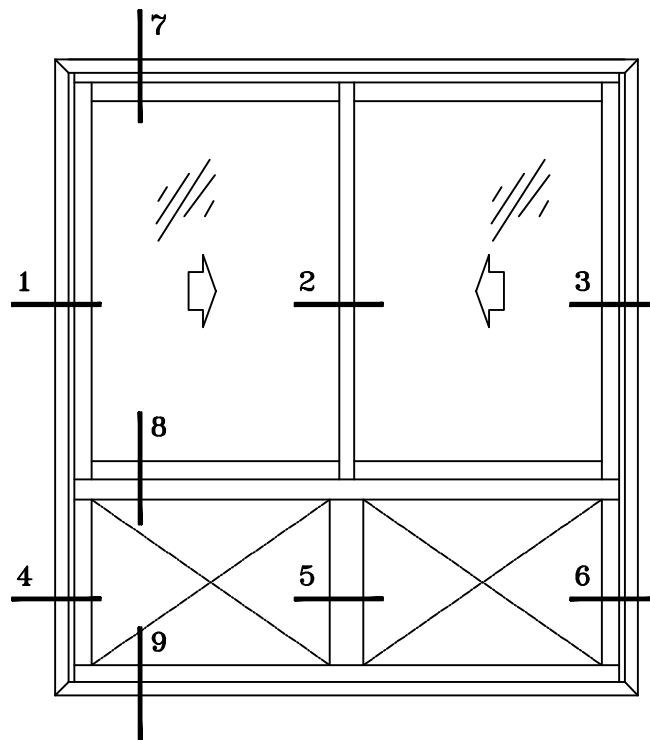

LINEA AW-90

Ventana Corrediza de Doble Hoja Con Fijo Interior

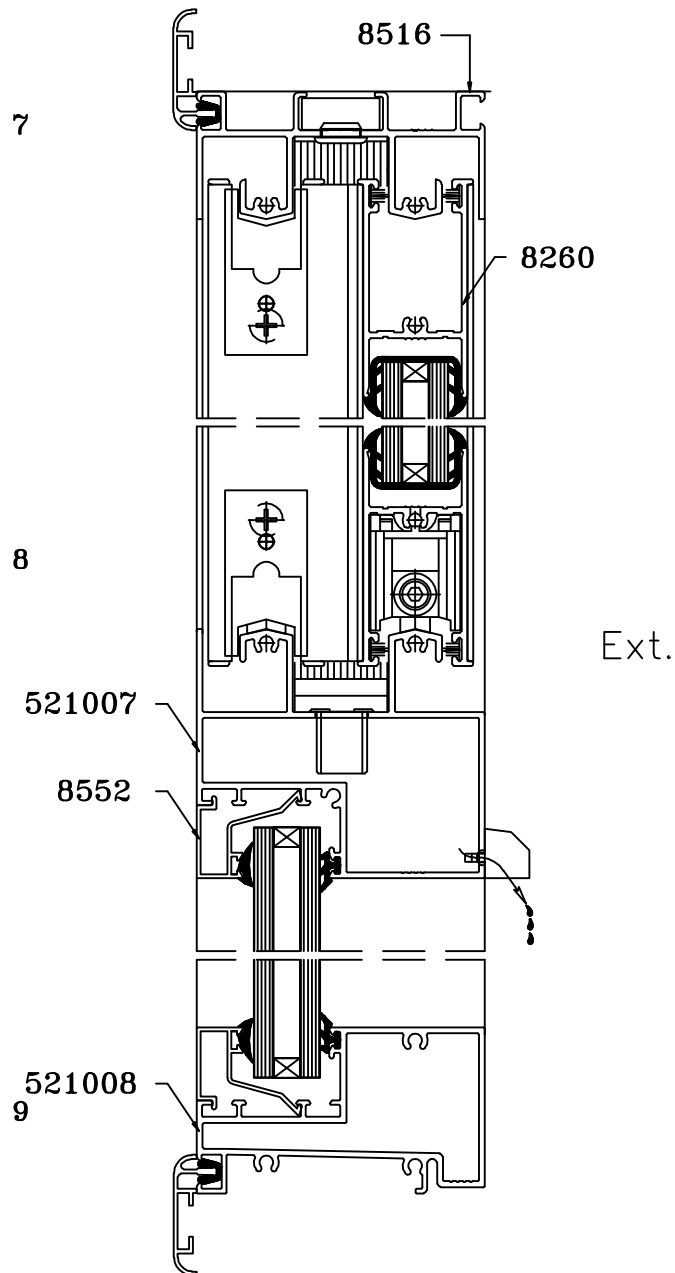

LINEA AW-90

Ventana Corrediza de Doble Hoja Con Fijo Interior

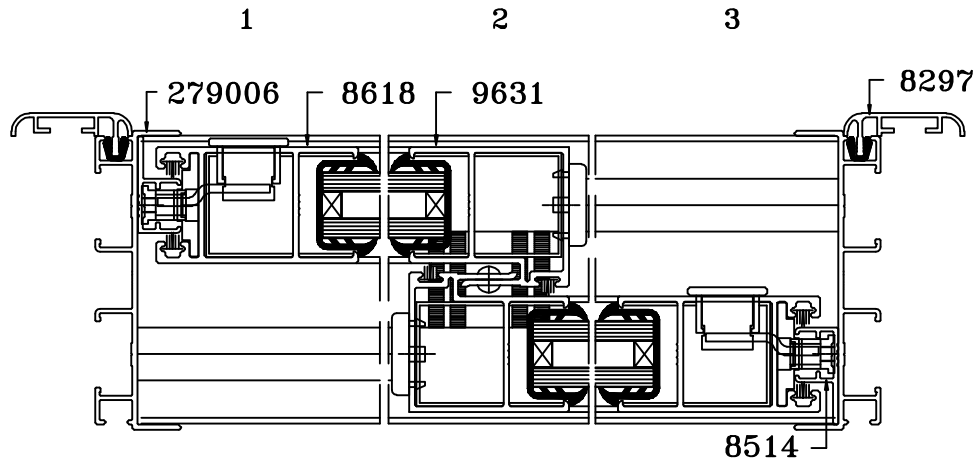

Ext.

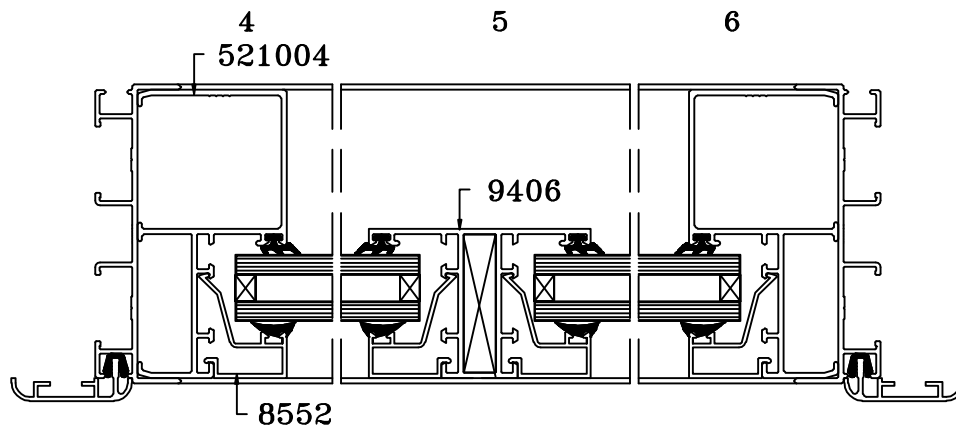

Ext.

LINEA AW-90

Ventana Corrediza de Triple Hoja Con Fijo Interior

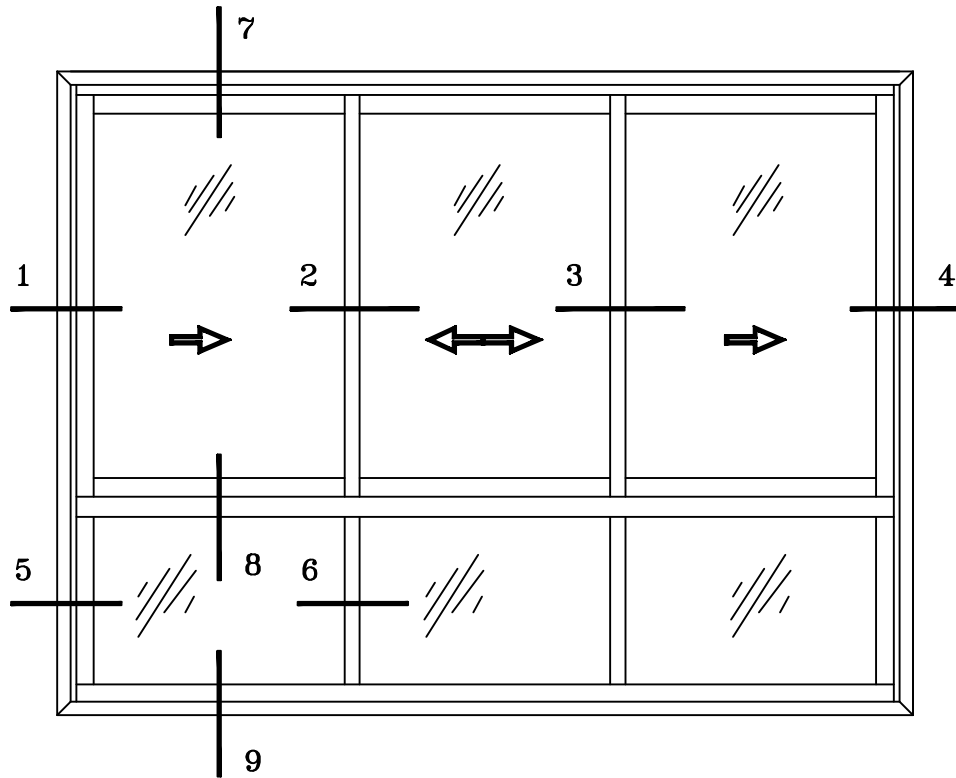

LINEA AW-90

Ventana Corrediza de Triple Hoja Con Fijo Interior

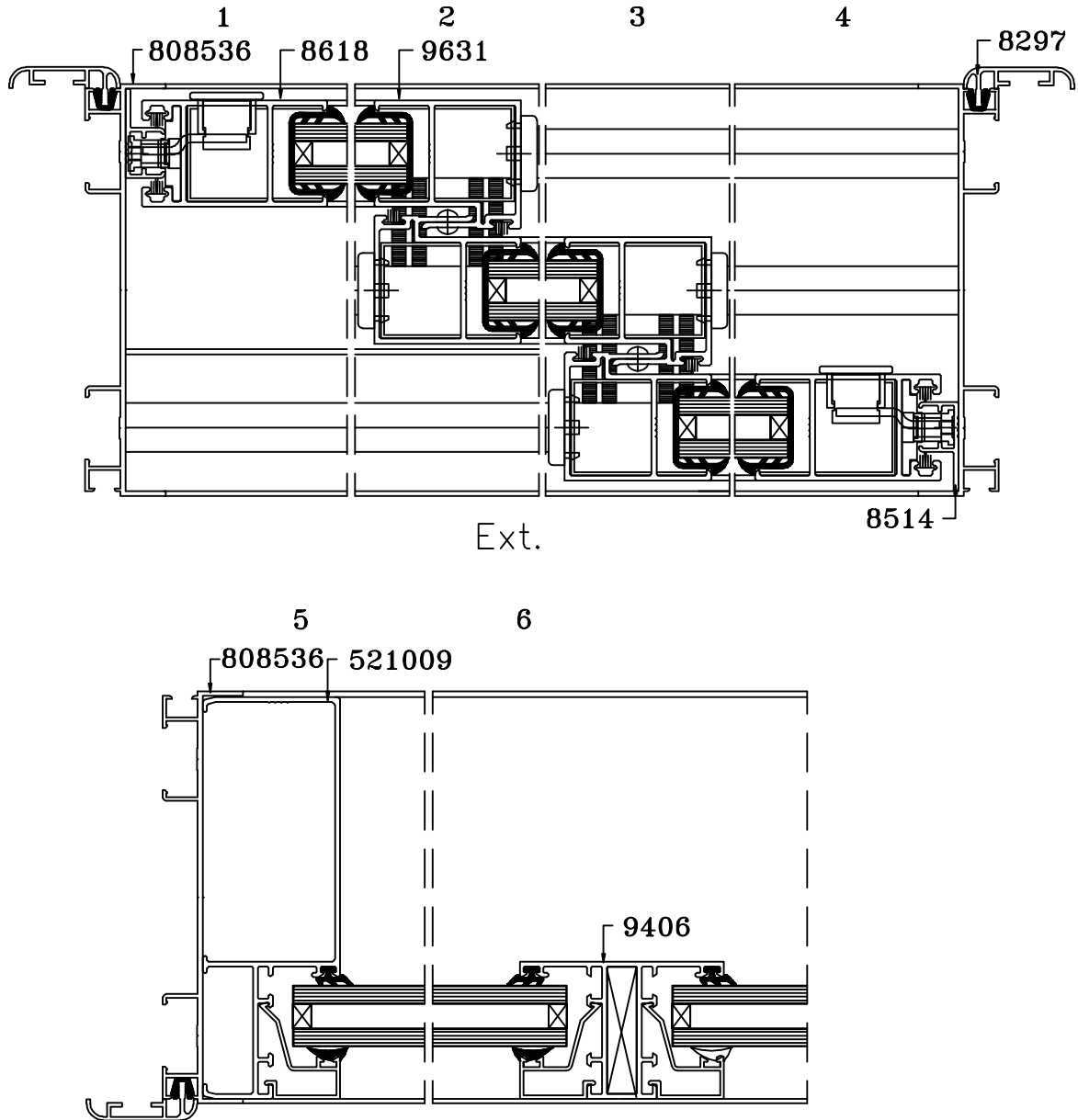

LINEA AW-90

Ventana Corrediza de Triple Hoja Con Fijo Interior

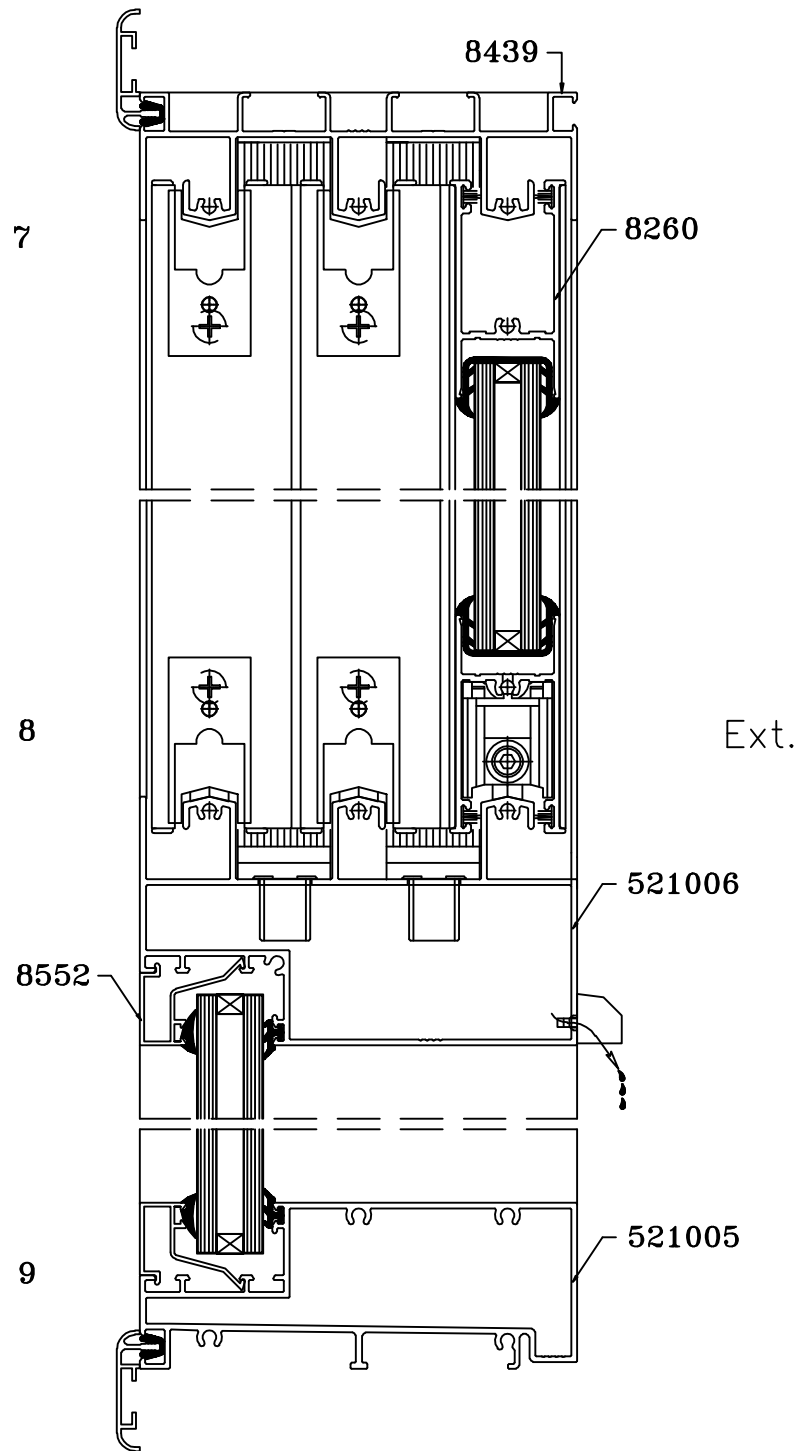

LINEA AW-90

Puerta Corrediza Doble

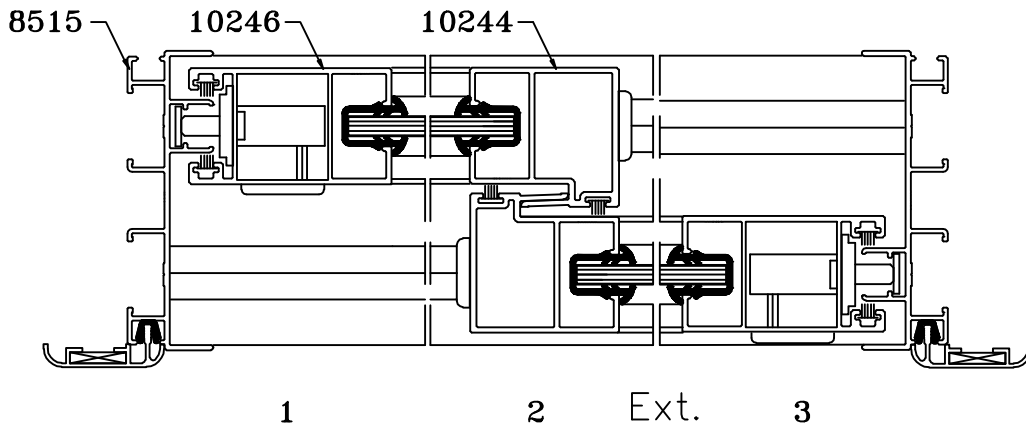
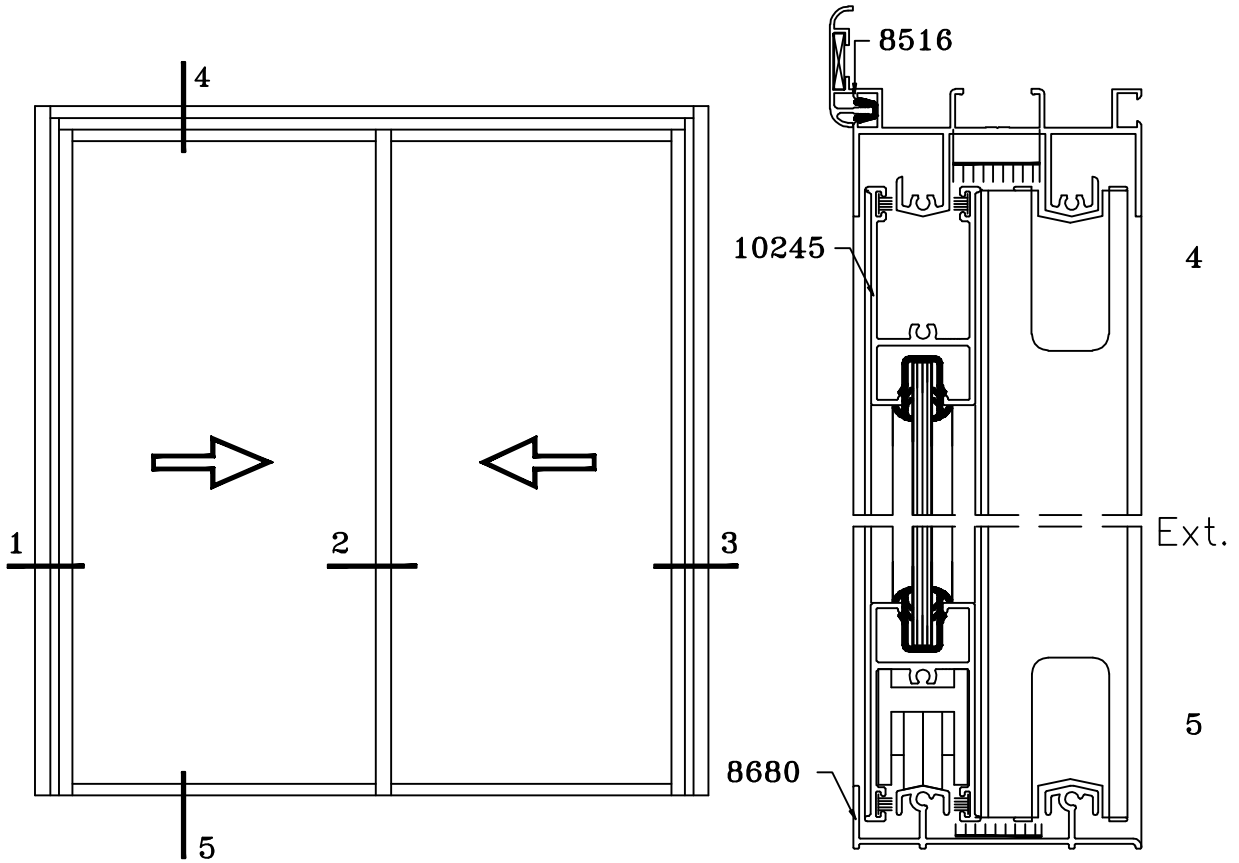

LINEA AW-90

Puerta Corrediza Triple con Division

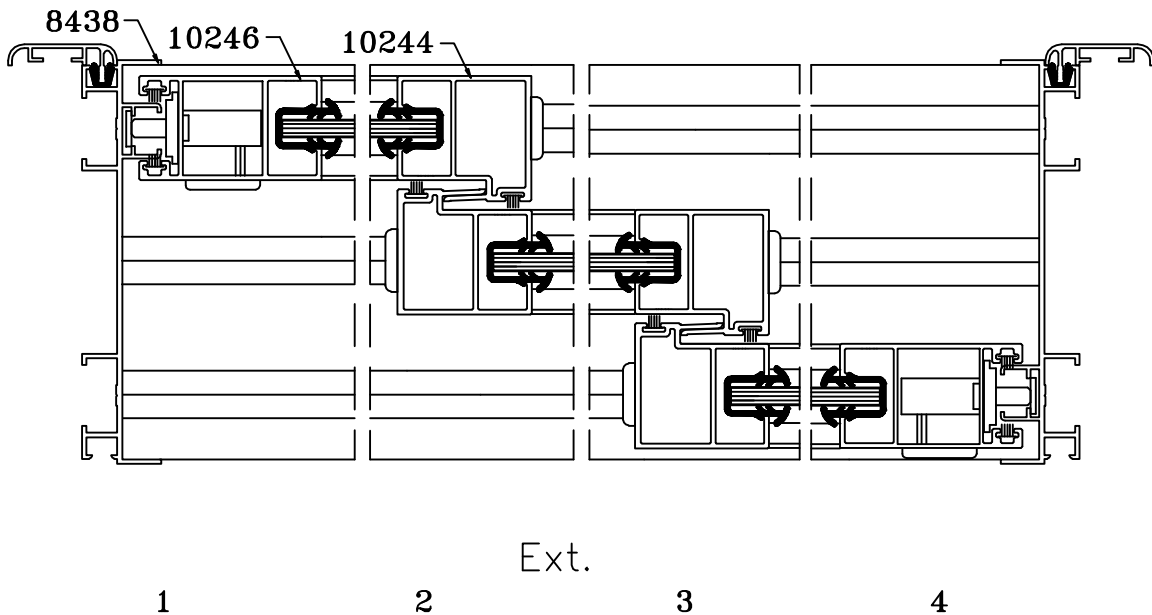
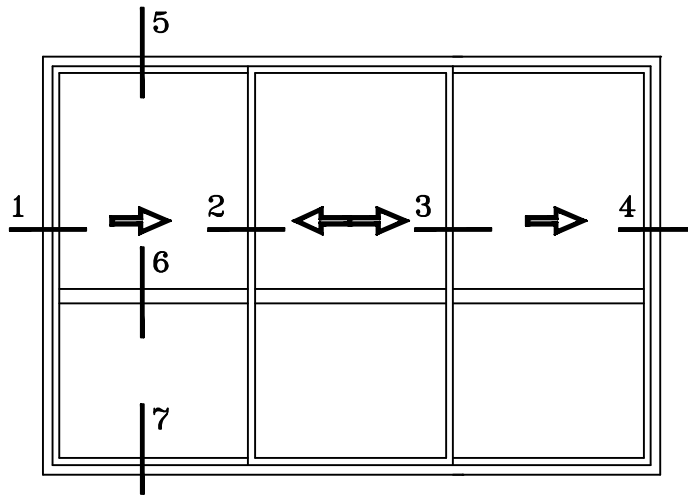

LINEA AW-90

Puerta Corrediza Triple con Division

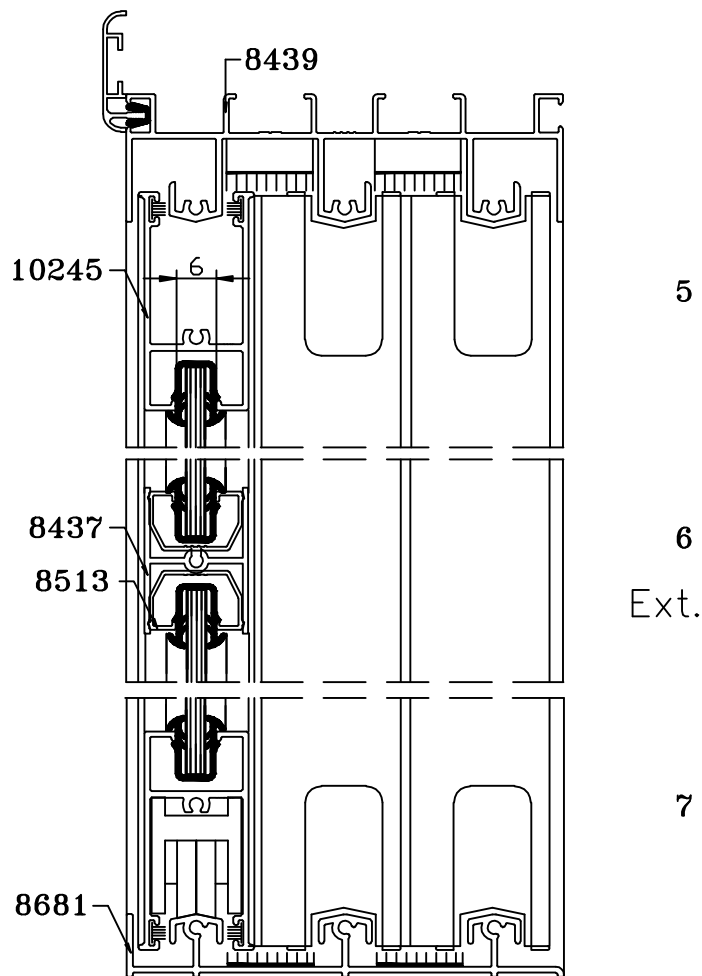

LINEA AW-90

Ventana Doble Corredizo Sin refuerzo

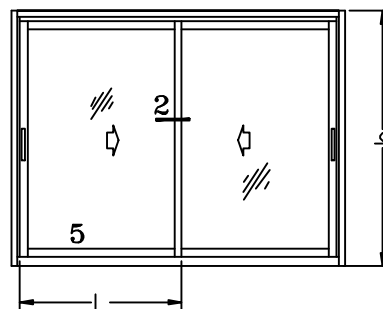
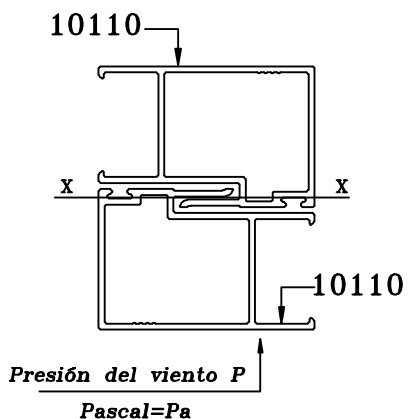

Momento de Inercia total

$$I_{xx} = 22.84 \text{ cm}^4$$

$$\Delta = L/200$$

Clase de Presión	Presión (Pa)	Velocidad de Viento (K/h)
A	500	101.7
B	840	131.8
C	1050	147.4
D	1260	161.5
E	1560	180.0

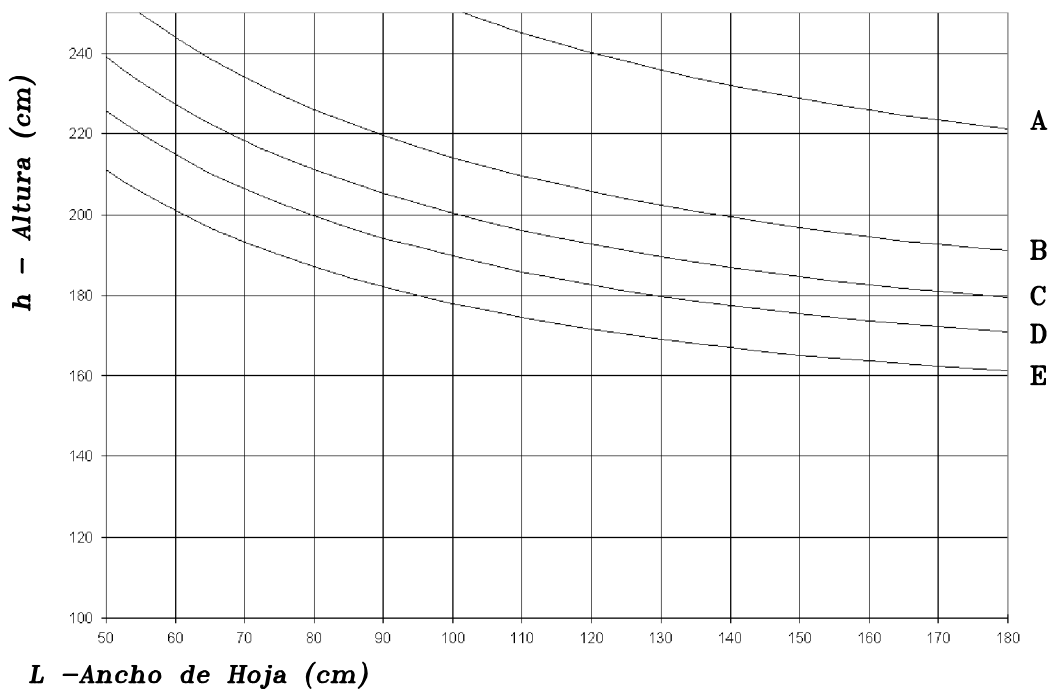

LINEA AW-90

Ventana Doble Corredizo Con Doble Refuerzo

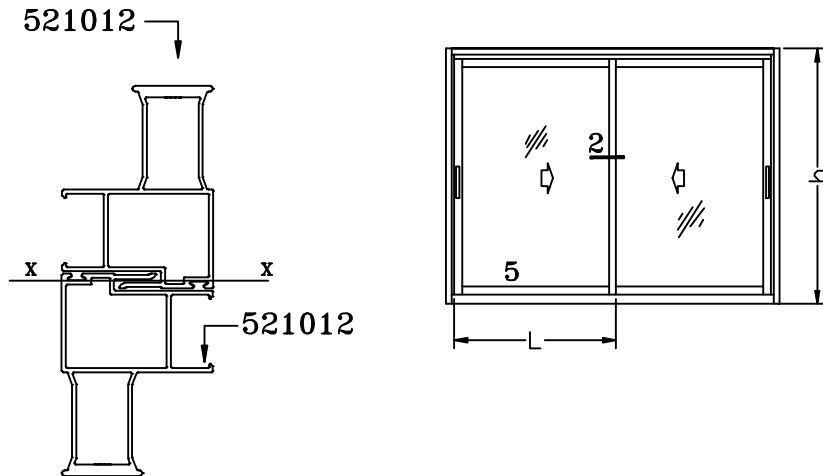

Presión del viento P
Pascal=Pa

Momento de Inercia total

$$I_{xx} = 136.90 \text{ cm}^4$$

$$\Delta = L/200$$

Clase de Presión	Presión (Pa)	Velocidad de Viento (K/h)
A	500	101.7
B	840	131.8
C	1050	147.4
D	1260	161.5
E	1560	180.0

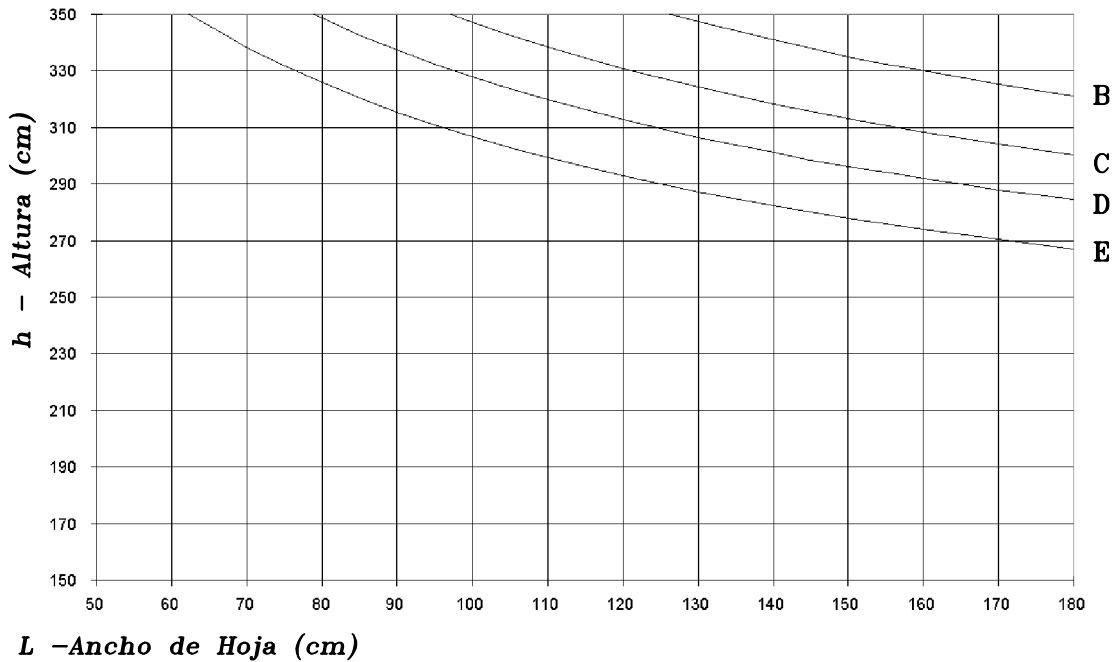

LINEA AW-90

Ventana Doble Corredizo Sin refuerzo

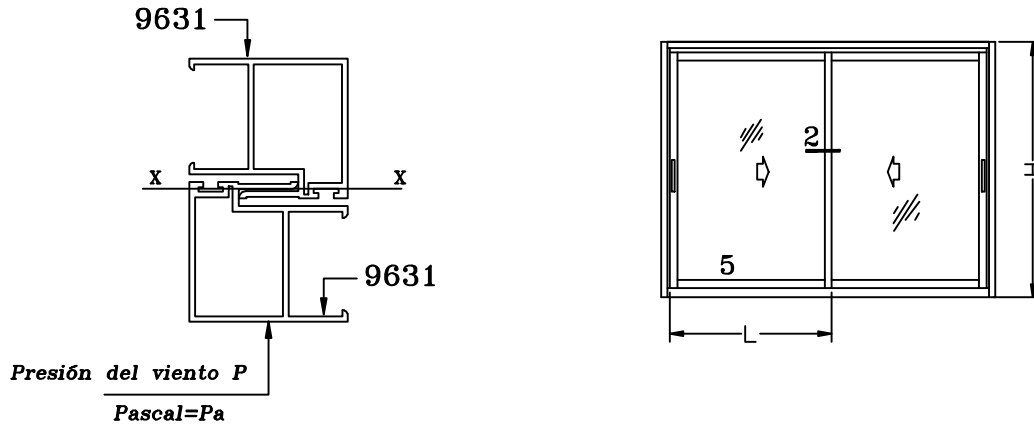

Momento de Inercia total

$$I_{xx} = 13.94 \text{ cm}^4$$

$$\Delta = 1/200$$

Clase de Presión	Presión (Pa)	Velocidad de Viento (K/h)
A	500	101.7
B	840	131.8
C	1050	147.4
D	1260	161.5
E	1560	180.0

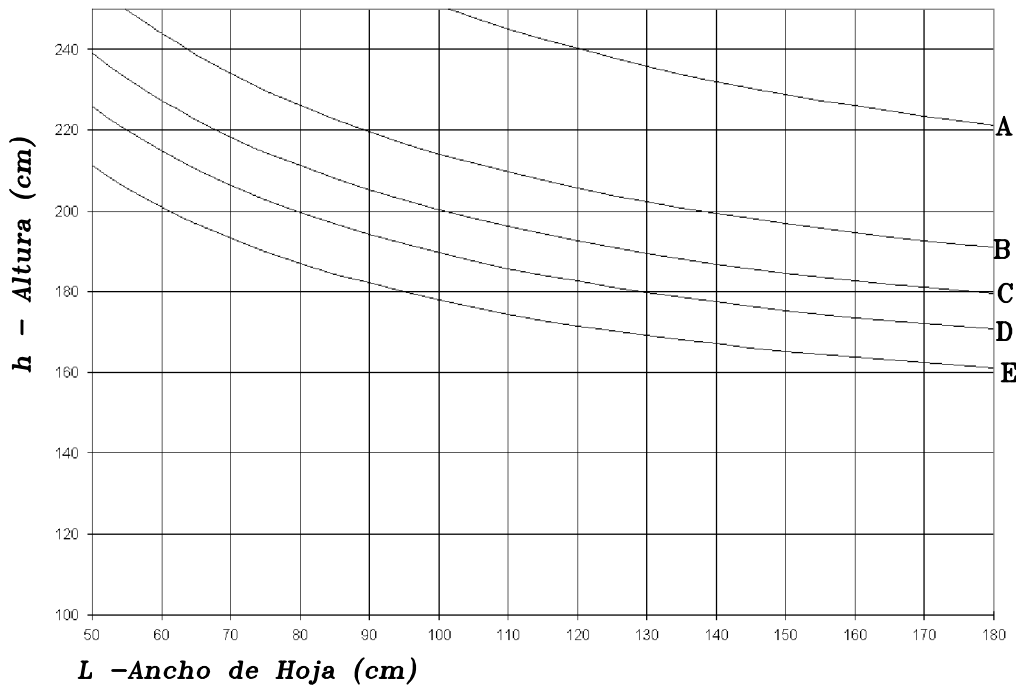

LINEA AW-90

Ventana Doble Corredizo Con Refuerzo Un Solo Lado

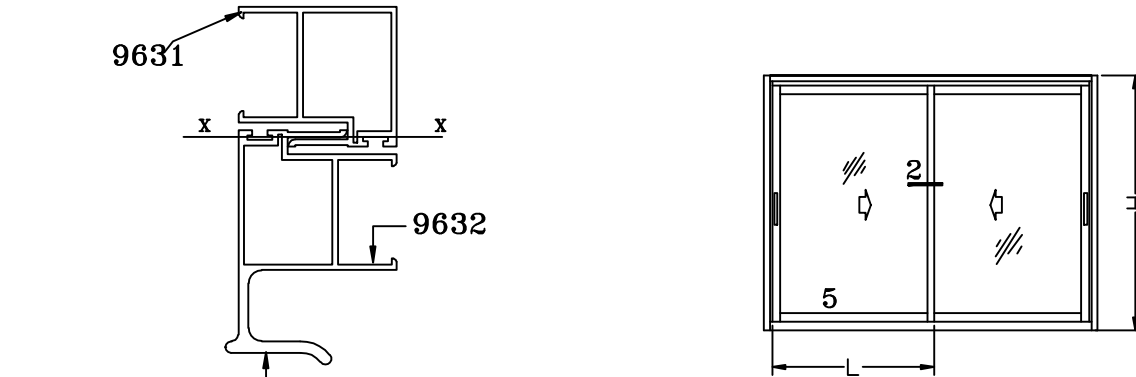

Presión del viento P
Pascal=Pa

Momento de Inercia total

$$I_{xx} = 17.0 \text{ cm}^4$$

$$\Delta = 1/200$$

Clase de Presión	Presión (Pa)	Velocidad de Viento (K/h)
A	500	101.7
B	840	131.8
C	1050	147.4
D	1260	161.5
E	1560	180.0

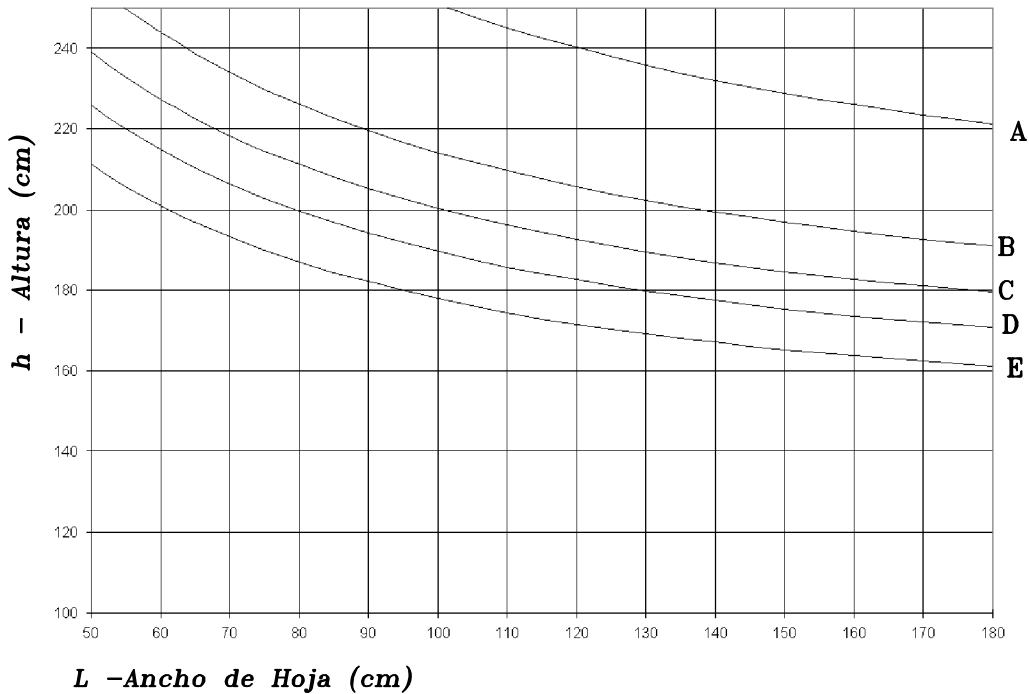

LINEA AW-90

Ventana Doble Corredizo Con Refuerzo Un Solo Lado

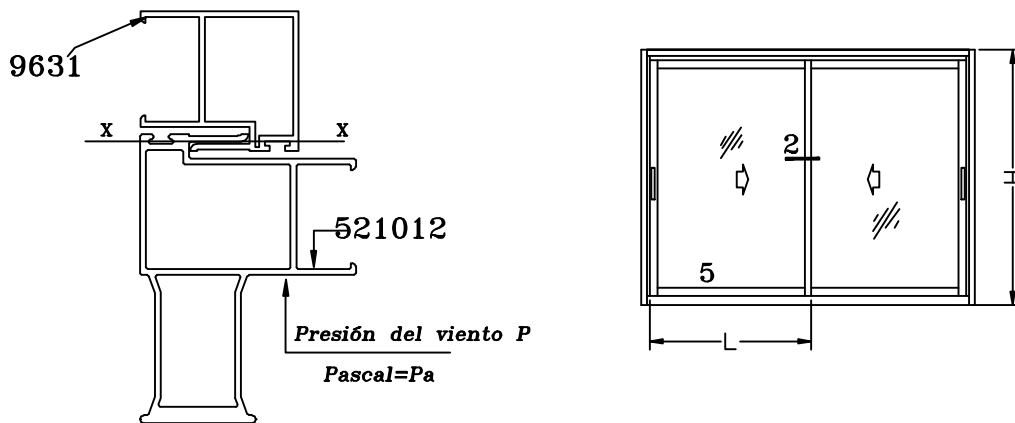

Momento de Inercia total

$$I_{xx} = 74.5 \text{ cm}^4$$

$$\Delta = 1/200$$

Clase de Presión	Presión (Pa)	Velocidad de Viento (K/h)
A	500	101.7
B	840	131.8
C	1050	147.4
D	1260	161.5
E	1560	180.0

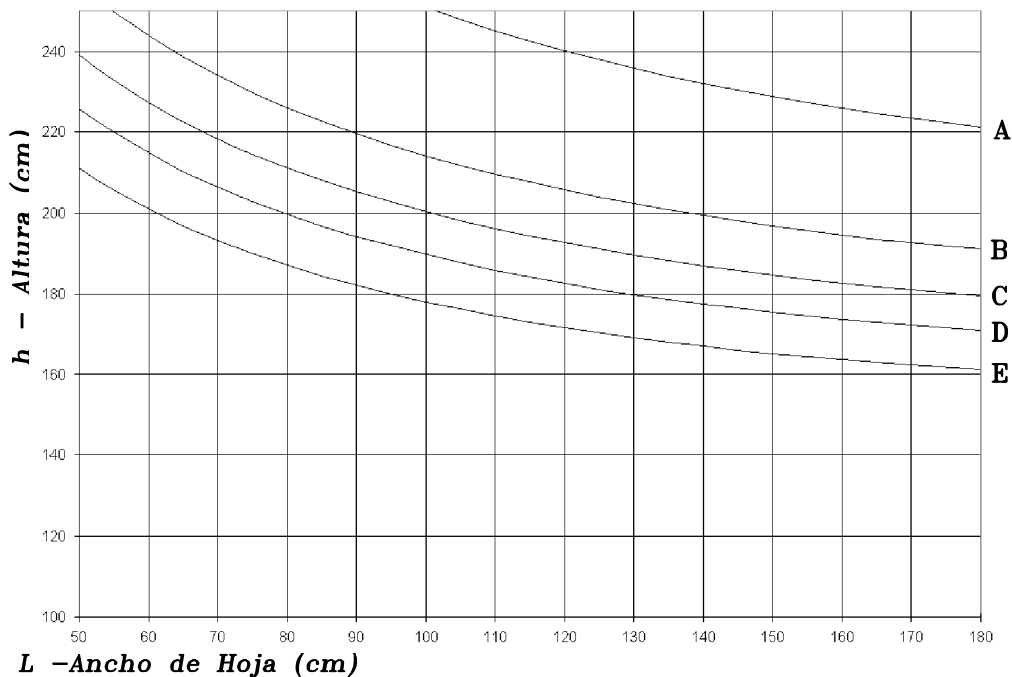

LINEA AW-90

Troquelados

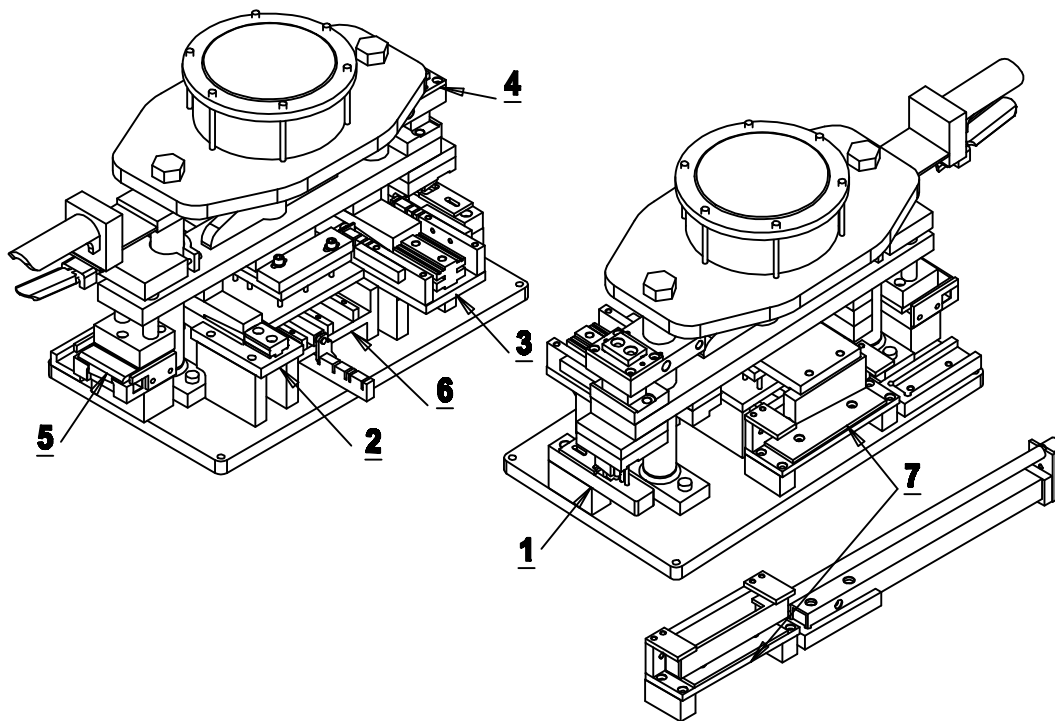

LINEA AW-90

Troquelados

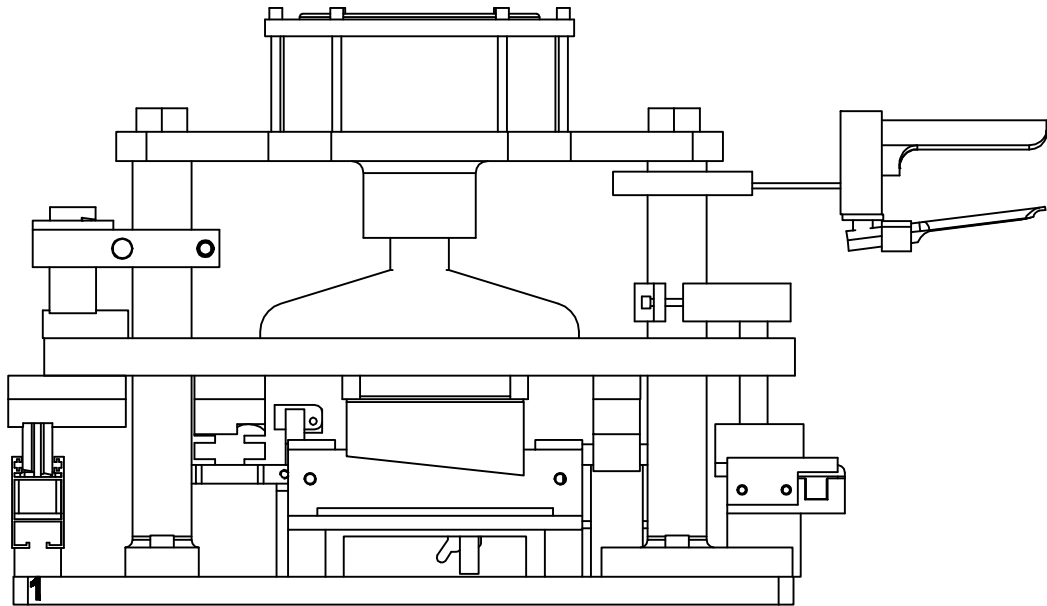

LINEA AW-90

Troquelados

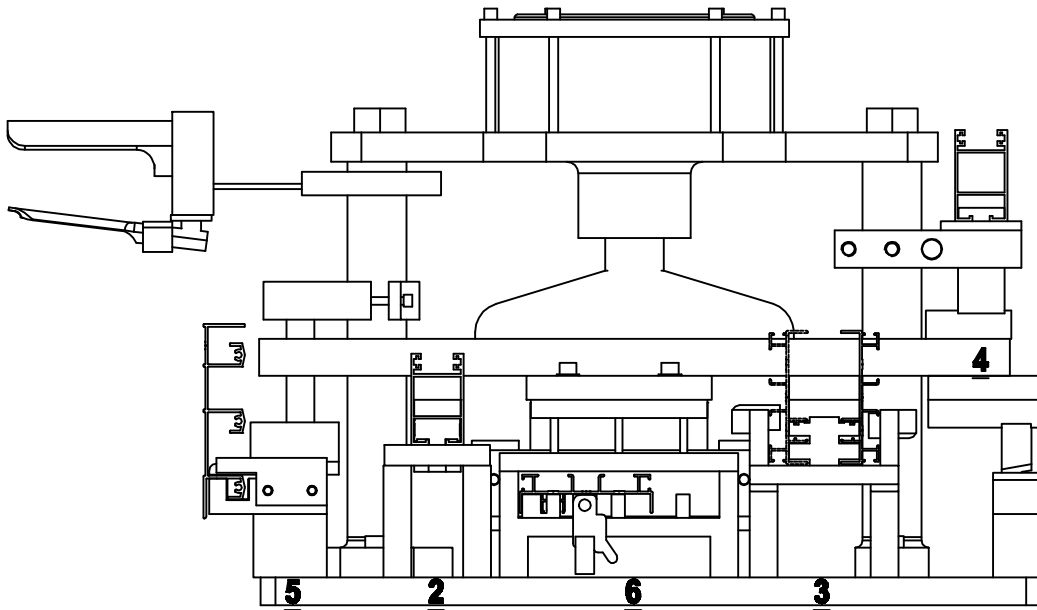

LINEA AW-90

Troquelados

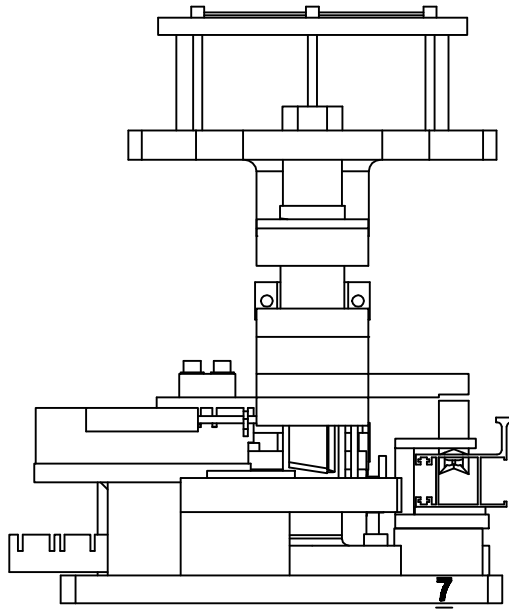

LINEA AW-90

Troquelados

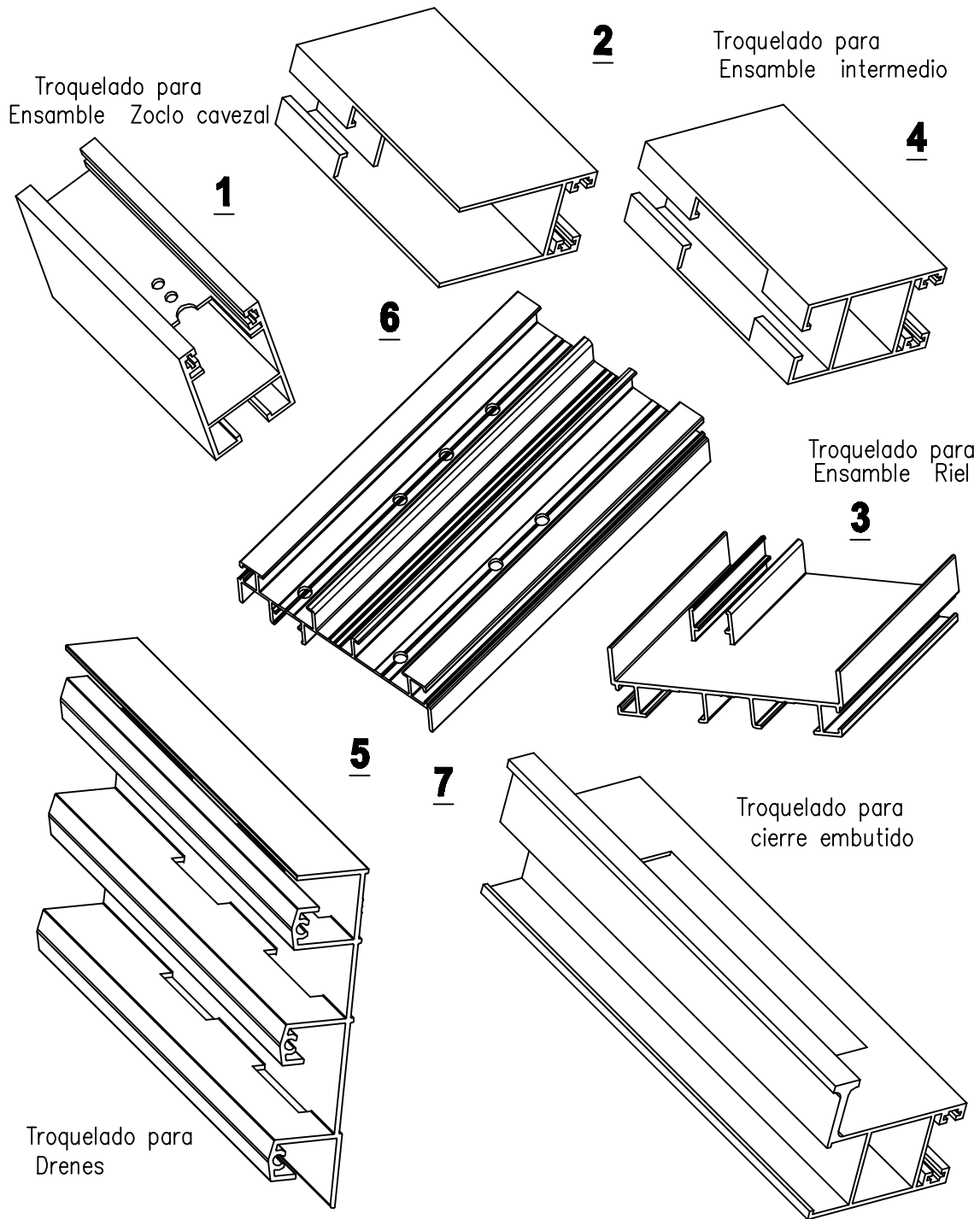

LINEA AW-90

Troquelados

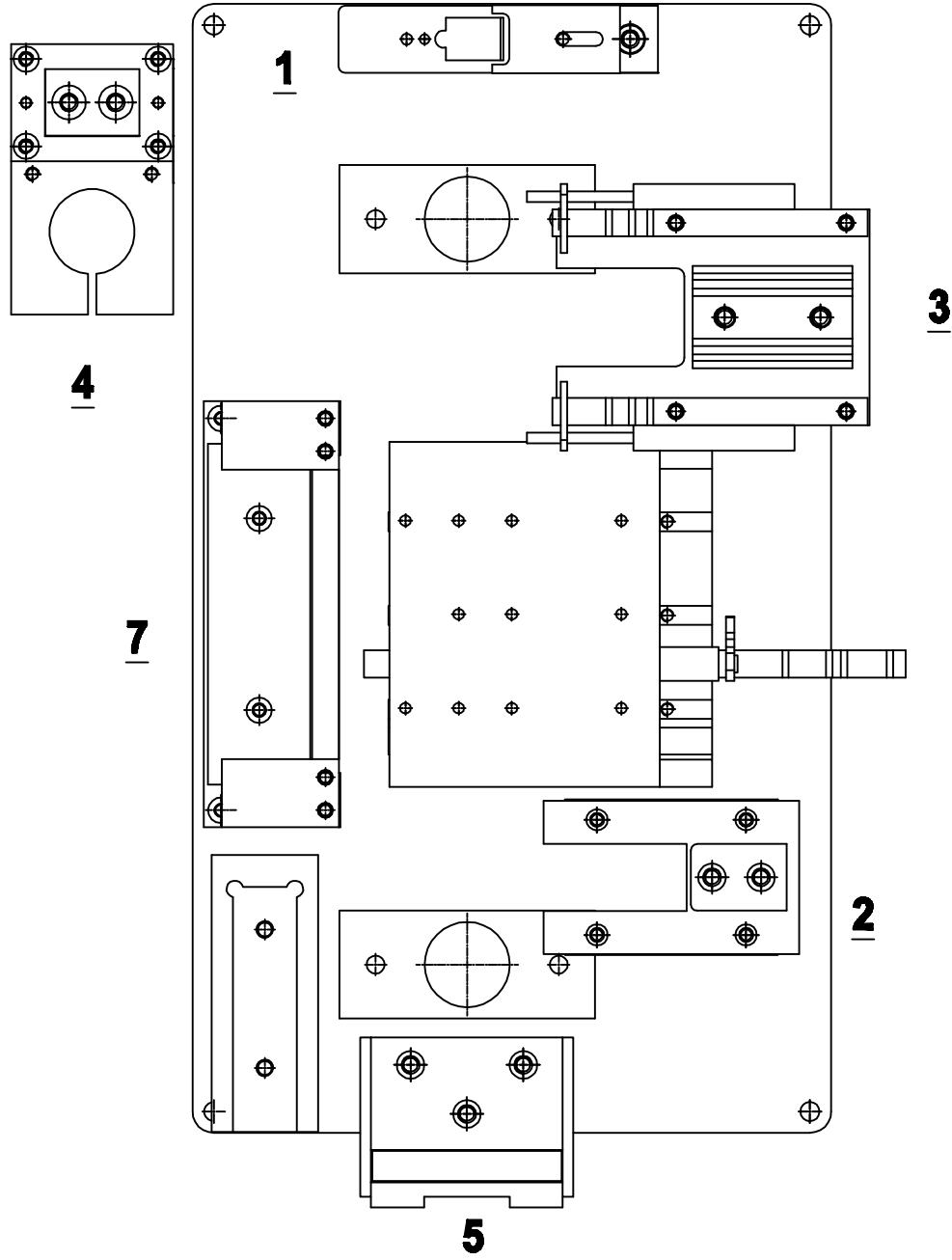

LINEA AW-90

Troquelados

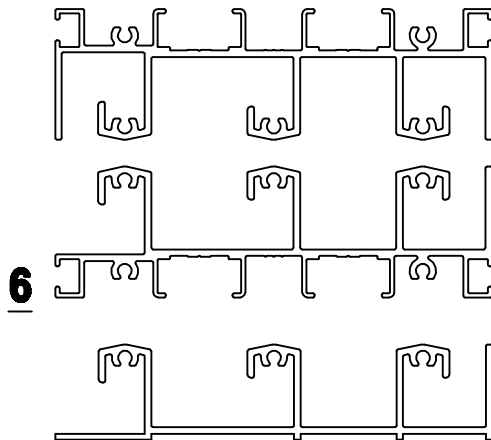
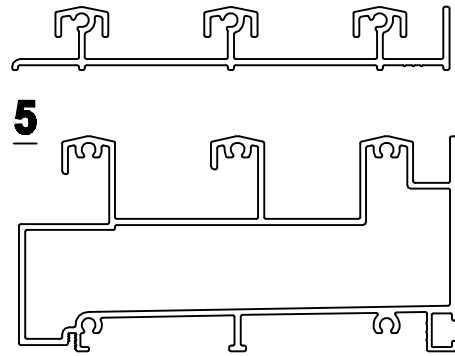
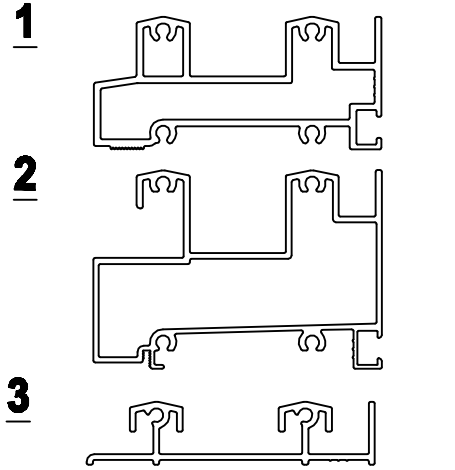
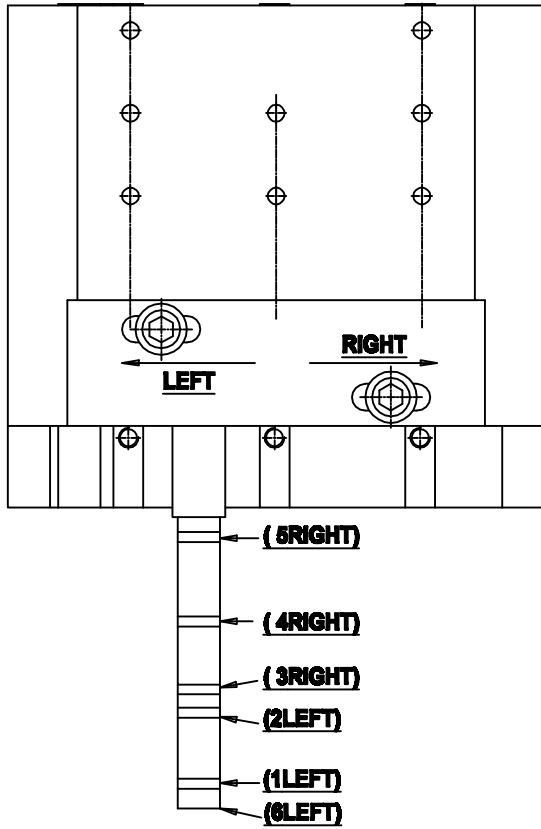

LINEA AW-90

Troquelados

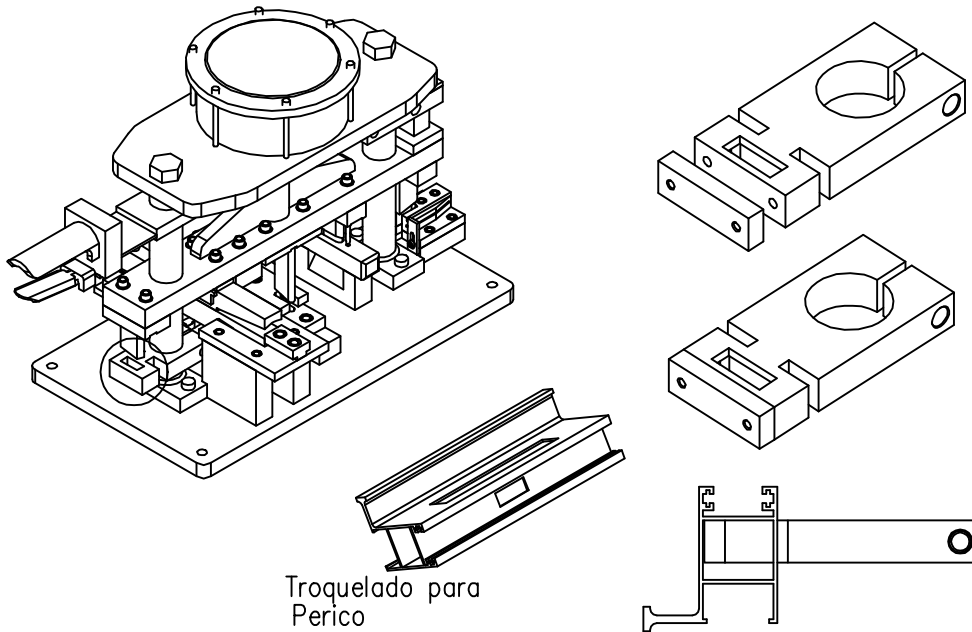

LINEA AW-90

Contacto



**Dirección: Calle 2 sur No.120
Parque Industrial Toluca 2000, Toluca**

C. P. 50200 Edo. de Mex.

Tel: (01 722) 262 15 00

Fax: (01 722) 262 15 09

01 800 288 02 00

Dirección E. : www.alubin.com.mx

E. Mail: ventas@alubin.com.mx